

JVC

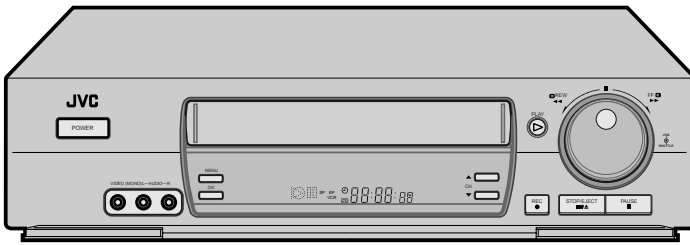

VIDEO CASSETTE RECORDER

HR-VP675U



VHS

Hi-Fi

SQP/B

VCRplus⁺ [®]
Cable Box
Control

Easy Taping.

MOVIE **▶▶ ADVANCE™**

INSTRUCTIONS

For Customer Use:

Enter below the Model No. and Serial No. which are located on the rear of cabinet. Retain this information for future reference.

Model No. _____

Serial No. _____

Dear Customer,

Thank you for purchasing the JVC VHS video cassette recorder. Before use, please read the safety information and precautions contained in the following pages to ensure safe use of your new VCR.

CAUTIONS

	CAUTION RISK OF ELECTRIC SHOCK DO NOT OPEN	
CAUTION: TO REDUCE THE RISK OF ELECTRIC SHOCK, DO NOT REMOVE COVER (OR BACK). NO USER-SERVICEABLE PARTS INSIDE. REFER SERVICING TO QUALIFIED SERVICE PERSONNEL.		



The lightning flash with arrowhead symbol, within an equilateral triangle, is intended to alert the user to the presence of uninsulated "dangerous voltage" within the product's enclosure that may be of sufficient magnitude to constitute a risk of electric shock to persons.



The exclamation point within an equilateral triangle is intended to alert the user to the presence of important operating and maintenance (servicing) instructions in the literature accompanying the appliance.

WARNING:
TO PREVENT FIRE OR SHOCK HAZARD, DO NOT EXPOSE THIS UNIT TO RAIN OR MOISTURE.

CAUTION:

This video cassette recorder should be used with AC 120V~, 60Hz only.
To prevent electric shocks and fire hazards, DO NOT use any other power source.

CAUTION:

TO PREVENT ELECTRIC SHOCK, MATCH WIDE BLADE OF PLUG TO WIDE SLOT, FULLY INSERT.

ATTENTION:

POUR ÉVITER LES CHOCS ÉLECTRIQUES, INTRODUIRE LA LAME LA PLUS LARGE DE LA FICHE DANS LA BORNE CORRESPONDANTE DE LA PRISE ET POUSSER JUSQU'AU FOND.

Note to CATV system installer:

This reminder is provided to call the CATV system installer's attention to Article 820-40 of the NEC that provides guidelines for proper grounding and, in particular, specifies that the cable ground shall be connected to the grounding system of the building, as close to the point of cable entry as practical.

CAUTION:

Changes or modifications not approved by JVC could void user's authority to operate the equipment.

Failure to heed the following precautions may result in damage to the VCR, remote control or video cassette.**1. DO NOT place the VCR . . .**

- ... in an environment prone to extreme temperatures or humidity.
- ... in direct sunlight.
- ... in a dusty environment.
- ... in an environment where strong magnetic fields are generated.
- ... on a surface that is unstable or subject to vibration.

2. DO NOT block the VCR's ventilation openings.**3. DO NOT place heavy objects on the VCR or remote control.****4. DO NOT place anything which might spill on top of the VCR or remote control.****5. AVOID violent shocks to the VCR during transport.******MOISTURE CONDENSATION**

Moisture in the air will condense on the VCR when you move it from a cold place to a warm place, or under extremely humid conditions—just as water droplets form on the surface of a glass filled with cold liquid. Moisture condensation on the head drum will cause damage to the tape. In conditions where condensation may occur, keep the VCR's power turned on for a few hours to let the moisture dry before inserting a tape.

****ABOUT HEAD CLEANING**

Accumulation of dirt and other particles on the video heads may cause the playback picture to become blurred or interrupted. Be sure to contact your nearest JVC dealer if such troubles occur.

VCR Plus+ C³ and PlusCode are registered trademarks of Gemstar Development Corporation.

The VCR Plus+ system is manufactured under license from Gemstar Development Corporation.

DSS™ is an official trademark of DIRECTV, Inc., a unit of GM Hughes Electronics. PRIMESTAR is a registered service mark of Primestar Partners, L.P. DISH Network™ is a trademark of EchoStar Communications Corporation.

MOVIE ADVANCE™ is a trademark of SRT, Inc. A Jerry Iggulden invention licensed in association with Arthur D. Little Enterprises, Inc.



- Cassettes marked "VHS" (or "S-VHS") can be used with this video cassette recorder. However, S-VHS recording is not possible with this model.
- This model is equipped with SQPB (S-VHS QUASI PLAYBACK) that makes it possible to play back S-VHS recordings with regular VHS resolution.
- HQ VHS is compatible with existing VHS equipment.
- As an ENERGY STAR® Partner, JVC has determined that this product or product model meets the ENERGY STAR® guidelines for energy efficiency.

IMPORTANT PRODUCT SAFETY INSTRUCTIONS

Electrical energy can perform many useful functions. But improper use can result in potential electrical shock or fire hazards. This product has been engineered and manufactured to assure your personal safety. In order not to defeat the built-in safeguards, observe the following basic rules for its installation, use and servicing.

ATTENTION:

Follow and obey all warnings and instructions marked on your product and its operating instructions. For your safety, please read all the safety and operating instructions before you operate this product and keep this booklet for future reference.

INSTALLATION

1. Grounding or Polarization

(A) Your product may be equipped with a polarized alternating-current line plug (a plug having one blade wider than the other). This plug will fit into the power outlet only one way. This is a safety feature.

If you are unable to insert the plug fully into the outlet, try reversing the plug. If the plug should still fail to fit, contact your electrician to replace your obsolete outlet. Do not defeat the safety purpose of the polarized plug.

(B) Your product may be equipped with a 3-wire grounding-type plug, a plug having a third (grounding) pin. This plug will only fit into a grounding-type power outlet. This is a safety feature.

If you are unable to insert the plug into the outlet, contact your electrician to replace your obsolete outlet. Do not defeat the safety purpose of the grounding-type plug.

2. Power Sources

Operate your product only from the type of power source indicated on the marking label. If you are not sure of the type of power supply to your home, consult your product dealer or local power company. If your product is intended to operate from battery power, or other sources, refer to the operating instructions.

3. Overloading

Do not overload wall outlets, extension cords, or integral convenience receptacles as this can result in a risk of fire or electric shock.

4. Power Cord Protection

Power supply cords should be routed so that they are not likely to be walked on or pinched by items placed upon or against them, paying particular attention to cords at plugs, convenience receptacles, and the point where they exit from the product.

5. Ventilation

Slots and openings in the cabinet are provided for ventilation. To ensure reliable operation of the product and to protect it from overheating, these openings must not be blocked or covered.

- Do not block the openings by placing the product on a bed, sofa, rug or other similar surface.
- Do not place the product in a built-in installation such as a bookcase or rack unless proper ventilation is provided or the manufacturer's instructions have been adhered to.

6. Wall or Ceiling Mounting

The product should be mounted to a wall or ceiling only as recommended by the manufacturer.

ANTENNA INSTALLATION INSTRUCTIONS

1. Outdoor Antenna Grounding

If an outside antenna or cable system is connected to the product, be sure the antenna or cable system is grounded so as to provide some protection against voltage surges and built-up static charges. Article 810 of the National Electrical Code, ANSI/NFPA 70, provides information with regard to proper grounding of the mast and supporting structure, grounding of the lead-in wire to an antenna discharge unit, size of grounding connectors, location of antenna discharge unit, connection to grounding electrodes, and requirements for the grounding electrode.

2. Lightning

For added protection for this product during a lightning storm, or when it is left unattended and unused for long periods of time, unplug it from the wall outlet and disconnect the antenna or cable system. This will prevent damage to the product due to lightning and power-line surges.

3. Power Lines

An outside antenna system should not be located in the vicinity of overhead power lines or other electric light or power circuits, or where it can fall into such power lines or circuits. When installing an outside antenna system, extreme care should be taken to keep from touching such power lines or circuits as contact with them might be fatal.

EXAMPLE OF ANTENNA GROUNDING AS PER NATIONAL ELECTRICAL CODE, ANSI/NFPA 70

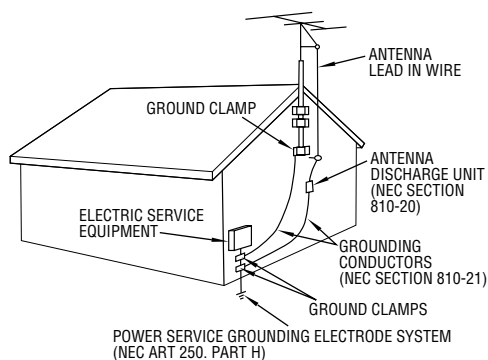

NEC – NATIONAL ELECTRICAL CODE

USE

1. Accessories

To avoid personal injury:

- Do not place this product on an unstable cart, stand, tripod, bracket, or table. It may fall, causing serious injury to a child or adult, and serious damage to the product.
- Use only with a cart, stand, tripod, bracket, or table recommended by the manufacturer or sold with the product.
- Use a mounting accessory recommended by the manufacturer and follow the manufacturer's instructions for any mounting of the product.
- Do not try to roll a cart with small casters across thresholds or deep-pile carpets.

2. Product and Cart Combination

A product and cart combination should be moved with care. Quick stops, excessive force, and uneven surfaces may cause the product and cart combination to overturn.

PORTABLE CART WARNING
(Symbol provided by RETAC)



3. Water and Moisture

Do not use this product near water—for example, near a bath tub, wash bowl, kitchen sink or laundry tub, in a wet basement, or near a swimming pool and the like.

4. Object and Liquid Entry

Never push objects of any kind into this product through openings as they may touch dangerous voltage points or short-out parts that could result in a fire or electric shock. Never spill liquid of any kind on the product.

5. Attachments

Do not use attachments not recommended by the manufacturer of this product as they may cause hazards.

6. Cleaning

Unplug this product from the wall outlet before cleaning. Do not use liquid cleaners or aerosol cleaners. Use a damp cloth for cleaning.

7. Heat

The product should be situated away from heat sources such as radiators, heat registers, stoves, or other products (including amplifiers) that produce heat.

SERVICING

1. Servicing

If your product is not operating correctly or exhibits a marked change in performance and you are unable to restore normal operation by following the detailed procedure in its operating instructions, do not attempt to service it yourself as opening or removing covers may expose you to dangerous voltage or other hazards. Refer all servicing to qualified service personnel.

2. Damage Requiring Service

Unplug this product from the wall outlet and refer servicing to qualified service personnel under the following conditions:

- a. When the power supply cord or plug is damaged.
- b. If liquid has been spilled, or objects have fallen into the product.
- c. If the product has been exposed to rain or water.
- d. If the product does not operate normally by following the operating instructions. Adjust only those controls that are covered by the operating instructions as an improper adjustment of other controls may result in damage and will often require extensive work by a qualified technician to restore the product to its normal operation.
- e. If the product has been dropped or damaged in any way.
- f. When the product exhibits a distinct change in performance—this indicates a need for service.

3. Replacement Parts

When replacement parts are required, be sure the service technician has used replacement parts specified by the manufacturer or have the same characteristics as the original part. Unauthorized substitutions may result in fire, electric shock or other hazards.

4. Safety Check

Upon completion of any service or repairs to this product, ask the service technician to perform safety checks to determine that the product is in safe operating condition.

HOW TO USE THIS INSTRUCTION MANUAL

- All major sections and subsections are listed in the Table Of Contents on page 5. Use this when searching for information on a specific procedure or feature.
- The Index on pages 56–59 lists frequently-used terms, and the number of the page on which they are used or explained in the manual. This section also illustrates the controls and connections on the front and rear panel, the front display panel and the remote control.
- The  mark signals a reference to another page for instructions or related information.
- Operation buttons necessary for the various procedures are clearly indicated through the use of illustrations at the beginning of each major section.

BEFORE YOU INSTALL YOUR NEW VCR . . .

. . . please read the sections/literature listed below.

- "Cautions" on page 2
- "Important Products Safety Instructions" on the previous pages

I	NSSTALLING YOUR NEW VCR	6
	Basic Connections	6
I	NITIAL SETTINGS	8
	Plug & Play	8
	Language	10
	Clock	11
	Preparation	11
	Semi-Auto	12
	Manual	13
	Tuner	14
	Set Receivable Channels	14
	Add Or Delete A Channel	15
	Cable Box Control	16
	Situating And Connecting Controller	16
	Set Cable Box Output Channel & Cable Box Brand	17
	DBS Receiver Control	19
	Situating And Connecting Controller	19
	Set DBS Receiver Output Channel & DBS Receiver Brand	20
S	IMPLE PLAYBACK AND RECORDING	22
	Simple Playback	22
	Simple Recording	23
P	LAYBACK AND RECORDING FEATURES	24
	Playback Features	24
	Still Picture/Frame-By-Frame Playback	24
	Slow Motion/Reverse Slow Motion	24
	Variable-Speed Search/Reverse Motion Playback	24
	High-Speed Search	25
	Skip Search	25
	Index Search	25
	Instant ReView	25
	Manual Tracking	25
	Picture Control	26
	Select The Soundtrack	27
	Video Stabilizer	27
	Repeat Playback	28
	Counter Reset	28
	Tape Position Indicator	28
	Next-Function Memory	28
	Superimpose	29
	Movie Advance	30
	AV COMPU LINK Playback	31
	Active Video Calibration	32
	Preparation	32
	Recording	33
	Playback	33
	Recording Features	34
	Record One Program While Watching Another	34
	Display Elapsed Recording Time	34
	Stereo And SAP (Second Audio Program)	35
	To Record SAP Programs	35

T	IMER RECORDING	36
	VCR Plus+ Timer Programming	36
	VCR Plus+ Setup	38
	Express Timer Programming	40
	Check, Cancel And Revise Programs	42
	Auto SP→EP Timer	43
	Auto Timer	43
	Instant Timer Recording (ITR)	44
E	DITING	45
	Edit To Or From Another VCR	45
	Edit From A Camcorder	46
S	PECIAL FEATURES	48
	TV Multi-Brand Remote Control	48
	Cable Box Multi-Brand Remote Control	49
	DBS Receiver Multi-Brand Remote Control	50
	Control Two JVC VCRs	51
	Child Lock	51
T	ROUBLESHOOTING	52
	Power	52
	Tape Transport	52
	Playback	52
	Recording	52
	Timer Recording	53
	Other Problems	54
Q	UESTIONS AND ANSWERS	55
	Playback	55
	Recording	55
	Timer Recording	55
I	NDEX	56
	List Of Terms	56
	Front View	57
	Rear View	58
	Front Display Panel	58
	Remote Control	59
S	PIFICATIONS	60
F	OR SERVICING (Only in U.S.A.)	61
W	ARRANTY (Only in U.S.A.)	62

Basic Connections

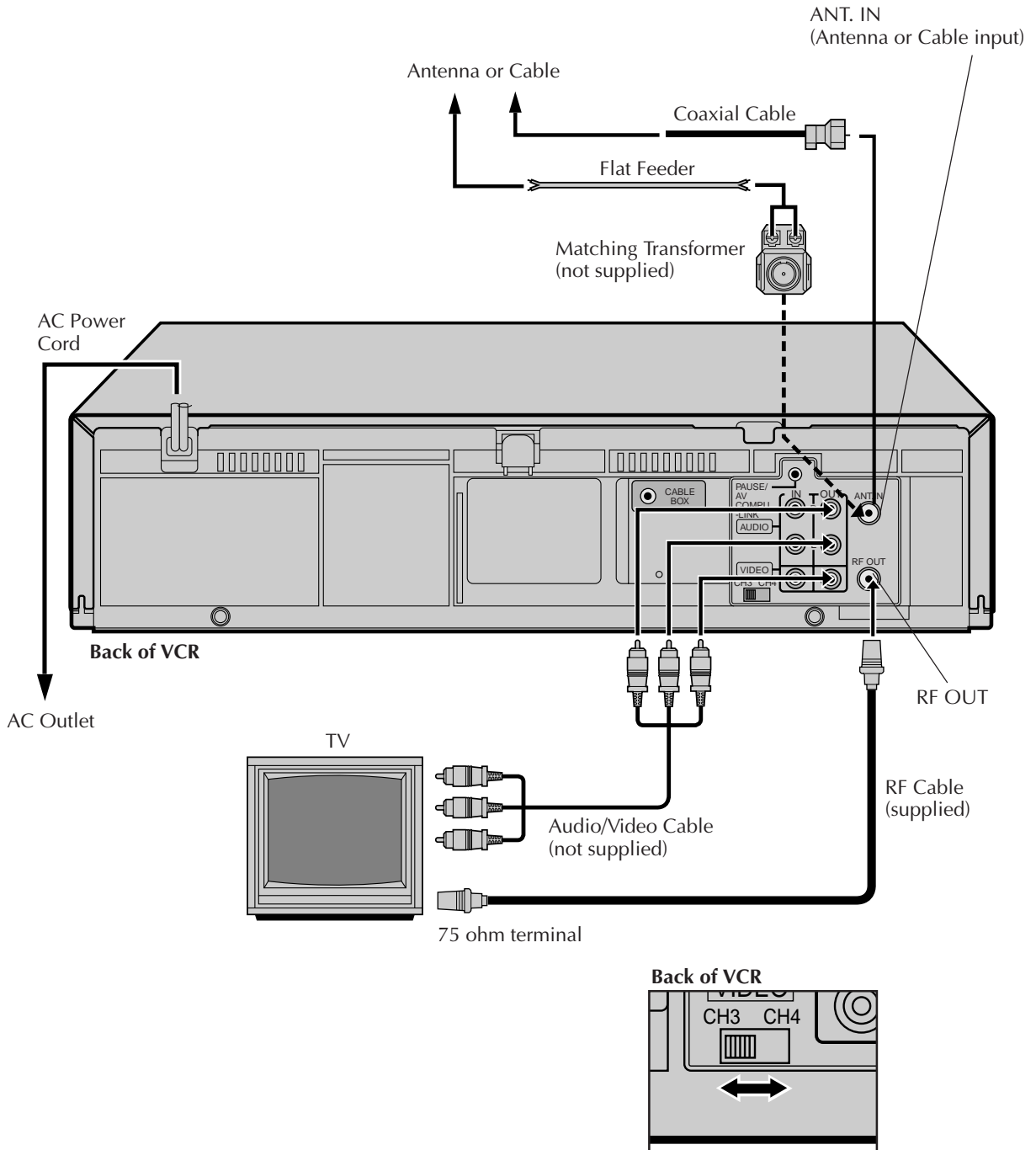

CHECK CONTENTS

1 Make sure the package contains all of the accessories listed in "SPECIFICATIONS" (☞ pg. 60).

SITUATE VCR

2 Place the VCR on a stable, horizontal surface.

CONNECT VCR TO TV

3 The connection method you use depends on the type of TV you have.

RF Connection

- *To Connect To A TV With NO AV Input Terminals . . .*
 - a- Disconnect the TV antenna from the TV.
 - b- Connect the TV antenna cable to the ANT. IN jack on the rear of the VCR.
 - c- Connect the supplied RF cable between the RF OUT jack on the rear of the VCR and the TV's antenna terminal. Set TV on CH3 or CH4 corresponding to the CH3 – CH4 switch setting on the back of the VCR.

AV Connection

- *To Connect To A TV With AV Input Terminals . . .*
 - a- Connect the antenna, VCR and TV as shown in the illustration.
 - b- Connect an Audio/Video Cable between the AUDIO OUT and VIDEO OUT jacks on the rear of the VCR and the AV IN jacks on the TV. Set your TV in video input mode or A/V input mode. Refer to the TV Instruction Manual.

CONNECT VCR TO POWER SOURCE

4 Connect the power plug to an AC outlet.

- The clock and tuner channels will automatically be set when the antenna is connected and when the AC is first connected to the VCR (☞ pg. 8).
(If "Auto" or "CH" is displayed on the front display panel before the VCR is powered on, the clock and tuner channels are being set automatically. Wait for the time to be displayed on the front display panel before powering on the VCR.)

FINAL PREPARATION FOR USE

5 Power on the VCR and select the VCR channel (3 or 4) by setting the switch on the rear of the VCR as shown in the illustration.

You can now perform simple playback (☞ pg. 22) or simple recording (☞ pg. 23).

NOTES:

- *The VCR channel is the channel on the TV which will display the audio and video signals from the VCR. The VCR's CH3-CH4 switch, on the back of the VCR, sets the VCR channel to CH3 or CH4.*
- *The CH3-CH4 switch is preset to the CH3 position. Set to CH4 if CH3 is used for broadcasting in your area and set the channel on the TV to correspond to the VCR's CH3-CH4 switch setting.*
- *If RF connection to TV is used, when switching from VCR to TV mode and from TV to VCR it may be necessary to issue a CH UP and then CH DOWN on TV to obtain a good quality picture.*
- *Even if you are using AV cables to connect your VCR to your TV, you must also connect it using the RF cable. This will ensure that you can record one show while watching another (☞ pg. 34).*
- *For full identification of the VCR's rear panel, refer to the Index (REAR VIEW ☞ pg. 58).*

Plug & Play

Auto Clock Set/Auto Tuner Set

ATTENTION

If you use a cable box, Plug & Play will not function; set the clock and tuner channels manually. (☞ pg.11 – 15)

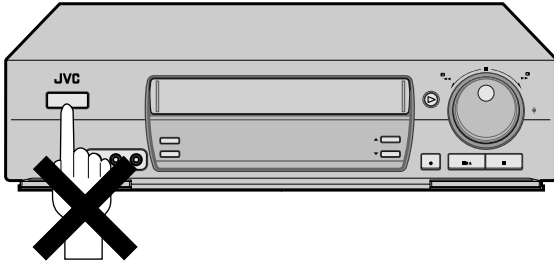

IMPORTANT

- Don't press any buttons on the VCR or remote while Plug & Play is in progress.
- If you perform Plug & Play successfully, there's no need to perform the Clock (☞ pg. 11) and Tuner (☞ pg. 14) procedures. If, however, you want to add or delete channels, refer to "Add Or Delete A Channel" on page 15.

The Plug & Play function sets the clock and tuner channels automatically when power is first connected to the VCR. The antenna cable must be connected for the Plug & Play function.

The time and date can be set automatically from clock setting data that is transmitted by one of the regular TV broadcast channels. We call this TV channel the "Host Channel" and it is a PBS channel in your area.

1 PLUG & PLAY SETUP

1 Connect the antenna cable to the VCR (☞ pg. 6). Then connect the VCR's power plug to an AC outlet. Do not power on the VCR. The clock and tuner channels will be set automatically.

NOTES:

- Auto clock set is performed first. The auto clock set function scans all the channels received by your VCR to find the Host Channel and then sets the clock. "Auto" blinks on the front display panel during Auto clock set.
- Auto channel set is performed next. The auto channel set function scans all the channels that are receivable by your VCR. It then automatically assigns each receivable channels to the CH▲▼ (+/-) buttons. It skips non-receivable channels. During auto channel set the channel numbers are displayed as they are scanned and set.
- When Plug & Play has been completed successfully the correct time is displayed.
- If an incorrect time or "--:--" appears on the display panel, see "What To Do If Plug & Play Has Failed" on next page.

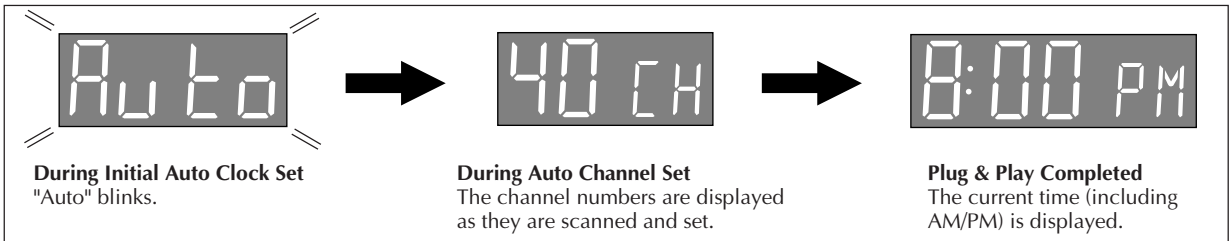

* If an incorrect time or "--:--" appears on the display panel, see "What To Do If Plug & Play Has Failed" on next page.

INFORMATION

- If "AUTO CLOCK" is set to "ON" at the Clock Set screen on page 12, the clock will be adjusted automatically by the host channel every hour on the hour (except for 11:00 PM, midnight, 1:00 AM and 2:00 AM) by the incoming PBS channel clock setting data. (This automatic clock adjustment can only be performed when the VCR's power is turned off. The clock will be adjusted on the hour based on the time displayed on the VCR, not on the actual real time.) The default setting of "AUTO CLOCK" is "ON".
- If the memory backup fails, because of a power outage or because the AC was removed from the VCR, Plug & Play will be performed when power is restored to the VCR.

What To Do If Plug & Play Has Failed

- If an incorrect time is displayed on the front display panel, you may be receiving the clock setting data of a PBS channel from an adjacent time zone, or an incorrect PBS channel from a cable TV system. In this case, perform the Semi-Auto (☞ pg. 12) or Manual Clock Set (☞ pg. 13) procedure. Auto channel set has already taken place and it need not be set again.
- If "--:--" appears on the display, your antenna cable may not be connected to the VCR or there may not be a Host PBS signal available in your area. Ensure that the antenna cable is connected correctly. Then power on and power off the VCR; the Plug & Play function will be automatically reactivated and "Auto" will be displayed on the VCR's front panel. If Plug & Play is not performed but the antenna cable is connected correctly, perform the Manual Clock Set procedure (☞ pg. 13). Auto channel set has not yet taken place, so please also perform the "Set Receivable Channels" procedure (☞ pg. 14).

Language

Turn on the TV and select the VCR channel 3 or 4 (or AV mode).

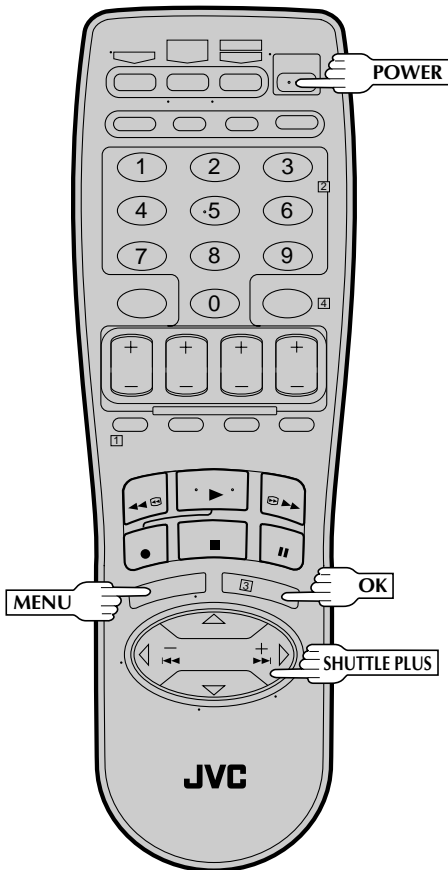
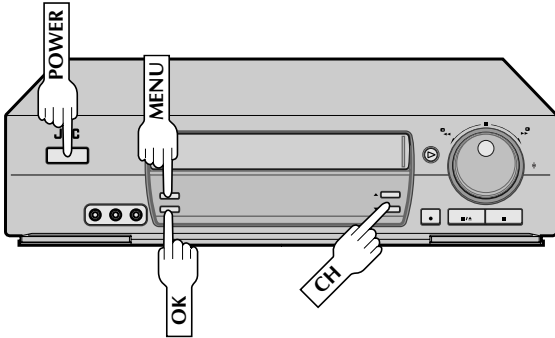

This VCR offers you the choice to view on-screen messages in English, Spanish or French (not including messages superimposed on the TV picture). Select the desired language using this procedure. The default setting is "ENGLISH".

1 TURN ON THE VCR

Press **POWER**.

2 ACCESS MAIN MENU SCREEN

Press **MENU**.

3 ACCESS INITIAL SET SCREEN

At the Main Menu screen, move the highlight bar (arrow) to "INITIAL SET" by pressing **CH▲▼** or **SHUTTLE PLUS▲▼**, then press **OK** or **SHUTTLE PLUS▷**.

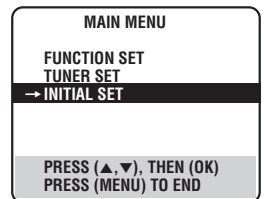

4 SELECT LANGUAGE

Move the highlight bar (arrow) to "LANGUAGE" by pressing **CH▲▼** or **SHUTTLE PLUS▲▼**, then press **OK** or **SHUTTLE PLUS▷** to select the desired language.

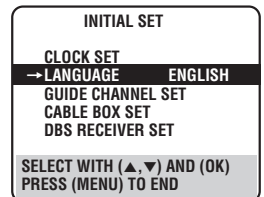

5 RETURN TO NORMAL SCREEN

Press **MENU**.

Clock

Turn on the TV and select the VCR channel 3 or 4 (or AV mode).

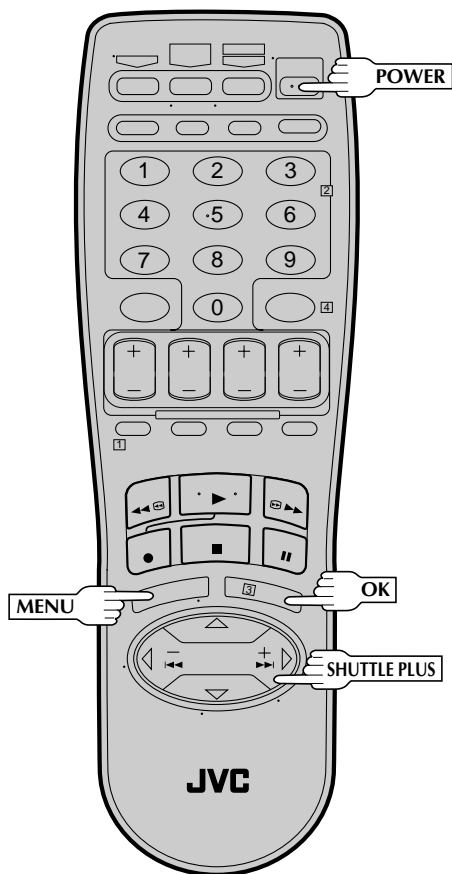
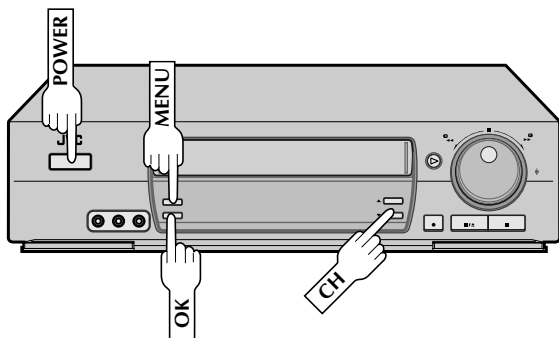

Perform clock setting only if the clock has not been set correctly by the Plug & Play function or you use a cable box. Access the Clock Set screen to perform the Semi-Auto or Manual clock setting procedure. Each procedure starts from step 5. If you use a cable box, set the clock manually. (pg. 13)

Preparation

1 TURN ON THE VCR

Press **POWER**.

2 ACCESS MAIN MENU SCREEN

Press **MENU**.

3 ACCESS INITIAL SET SCREEN

At the Main Menu screen, move the highlight bar (arrow) to "INITIAL SET" by pressing **CH▲▼** or **SHUTTLE PLUS▲▼**, then press **OK** or **SHUTTLE PLUS ▷**.

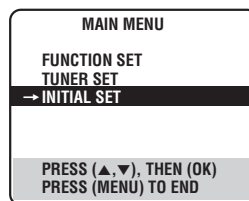

4 ACCESS CLOCK SET SCREEN

Move the highlight bar (arrow) at the Initial Set screen to "CLOCK SET" by pressing **CH▲▼** or **SHUTTLE PLUS▲▼**, then press **OK** or **SHUTTLE PLUS ▷**.

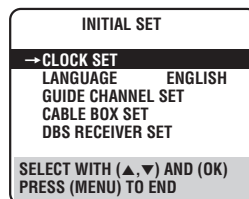

- "CABLE BOX USERS SET CLOCK MANUALLY" appears on the screen for about 5 seconds, then the Clock Set screen appears.

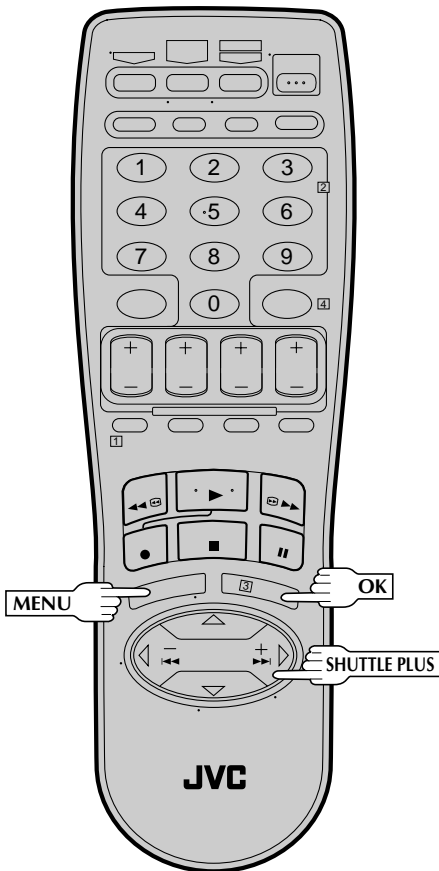
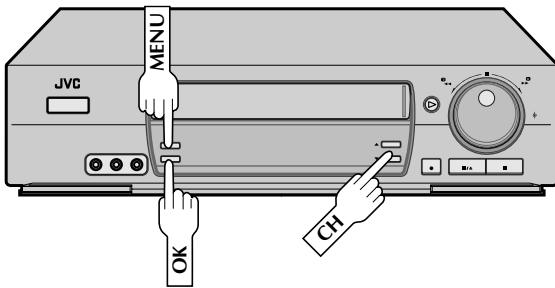

Semi-Auto

You can change the Host Channel/D.S.T. /Time Zone setting manually.

5

SET AUTO CLOCK TO ON

At the Clock Set screen, press **OK** or **SHUTTLE PLUS** \triangleright to move the highlight bar to "AUTO CLOCK" and press **CH** $\blacktriangle\blacktriangledown$ or **SHUTTLE PLUS** $\triangle\triangledown$ to set to "ON".

- a- To select the Host Channel — go to step 6
- b- To select the D.S.T. mode — go to step 7
- c- To select the Time Zone — go to step 8

CLOCK SET			
TIME	DATE	YEAR	
1:00PM	12/24	99 THU	
AUTO CLOCK : ON			
HOST CH	AUTO (CATV)		
D.S.T.	: AUTO		
TIME ZONE	: AUTO		
PRESS ($\blacktriangle, \blacktriangledown$), THEN (OK)			
PRESS (MENU) TO END			

NOTE:

The time that has been set previously will be erased when "AUTO CLOCK", "HOST CH", "D.S.T." or "TIME ZONE" setting is changed.

6

SELECT HOST CHANNEL

You can either select "AUTO" or enter a PBS channel number. Move the highlight bar to "HOST CH" by pressing **OK** or **SHUTTLE PLUS** \triangleright , then press **CH** $\blacktriangle\blacktriangledown$ or **SHUTTLE PLUS** $\triangle\triangledown$ to set to "AUTO" or the desired PBS channel number.

NOTE:

There are some PBS channels that do not transmit clock setting data.

7

SELECT D.S.T. MODE

You have three choices:

- a- Select "AUTO" and the adjustment to your VCR's clock will be made according to the incoming signal from the host channel.
- b- Select "ON" and the adjustment will be made based on the clock itself.
- c- Select "OFF" if Daylight Saving Time does not apply to you.

Move the highlight bar to "D.S.T." by pressing **OK** or **SHUTTLE PLUS** \triangleright , then press **CH** $\blacktriangle\blacktriangledown$ or **SHUTTLE PLUS** $\triangle\triangledown$ to select the desired mode.

**AUTO DAYLIGHT SAVING TIME

This function enables automatic adjustment of the VCR's clock at the start and end of Daylight Saving Time.

With Auto DST activated, . . .

. . . on the first Sunday of April at 2:00 AM, the clock is adjusted to 3:00 AM.

. . . on the last Sunday of October at 2:00 AM, the clock is adjusted to 1:00 AM.

8 SELECT TIME ZONE

8 You can select the time zone automatically or manually. Move the highlight bar to "TIME ZONE" by pressing **OK** or **SHUTTLE PLUS** \triangleright , then press **CH** \blacktriangle \blacktriangledown or **SHUTTLE PLUS** \triangle \triangledown to select "AUTO" or the desired time zone.

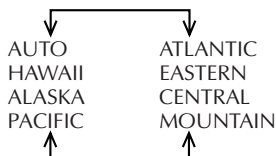

NOTE:

If an incorrect time is displayed by the Plug & Play function, you may be receiving the clock setting data of a PBS channel from an adjacent time zone or from an incorrect PBS channel from a cable TV system. If you selected "AUTO" for the host channel in step 6, be sure to select the correct time zone manually.

9 RETURN TO NORMAL SCREEN

Press **MENU**.

IMPORTANT

Turn the VCR off after performing the Semi-Auto Clock Set procedure. "Auto" will appear on the front display panel when the clock is being set. The current time will appear automatically when the clock is set.

Manual

5 SET TIME

Press **CH** \blacktriangle \blacktriangledown or **SHUTTLE PLUS** \triangle \triangledown until the desired time appears, then press **OK** or **SHUTTLE PLUS** \triangleright .

- Press and hold **CH** \blacktriangle \blacktriangledown or **SHUTTLE PLUS** \triangle \triangledown to change the time by 30 minutes.
- When the time is entered manually, "AUTO CLOCK" will be automatically set to "OFF", and "HOST CH" and "TIME ZONE" will disappear.

CLOCK SET			
TIME	DATE	YEAR	
--:--AM	1/1	99	
AUTO CLOCK: ON			
HOST CH	: AUTO	(CATV)	
D.S.T.	: AUTO		
TIME ZONE	: AUTO		
PRESS (\blacktriangle , \blacktriangledown), THEN (OK)			
PRESS (MENU) TO END			

6 SET DATE

Press **CH** \blacktriangle \blacktriangledown or **SHUTTLE PLUS** \triangle \triangledown until the desired date appears, then press **OK** or **SHUTTLE PLUS** \triangleright .

- Press and hold **CH** \blacktriangle \blacktriangledown or **SHUTTLE PLUS** \triangle \triangledown to change the date by 15 days.

7 SET YEAR

Press **CH** \blacktriangle \blacktriangledown or **SHUTTLE PLUS** \triangle \triangledown until the desired year appears, then press **OK** or **SHUTTLE PLUS** \triangleright twice.

8 SELECT D.S.T. MODE

Press **CH** \blacktriangle \blacktriangledown or **SHUTTLE PLUS** \triangle \triangledown to select the desired mode.

- Set to "ON" so that the adjustment to your VCR's clock will be made on the clock itself.
- Set to "OFF" if Daylight Saving Time does not apply to you.

9 START CLOCK

Press **MENU** and normal screen appears.

To Make Corrections

Press **OK** or **SHUTTLE PLUS** \triangleright until the item you want to change blinks, then press **CH** \blacktriangle \blacktriangledown or **SHUTTLE PLUS** \triangle \triangledown .

Tuner

Turn on the TV and select the VCR channel 3 or 4 (or AV mode).

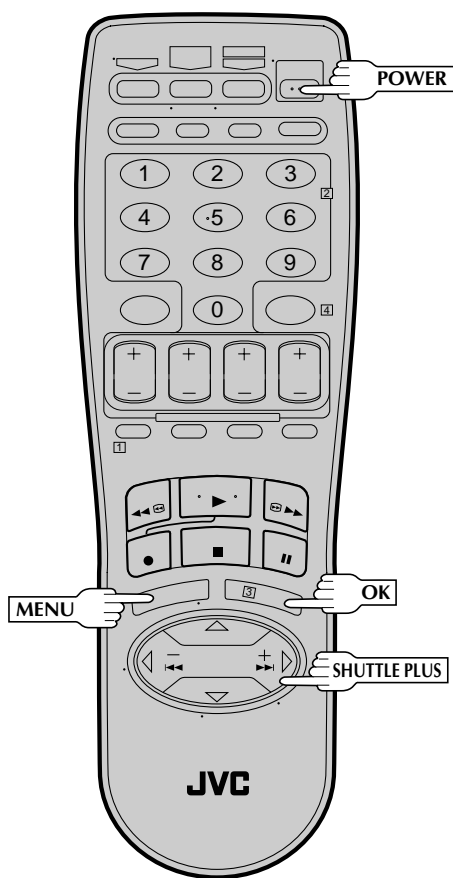
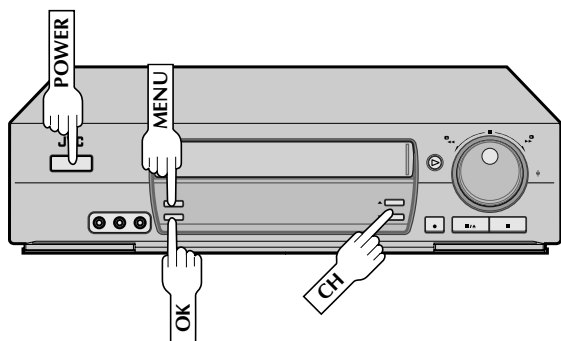

INFORMATION

The VCR detects the band (TV or CATV) and selects the correct band automatically during Auto Channel Set. The selected band will be displayed on the right side of "BAND" on the Tuner Set screen.

Set Receivable Channels

1 TURN ON THE VCR

Press **POWER**.

2 ACCESS MAIN MENU SCREEN

Press **MENU**.

3 ACCESS TUNER SET SCREEN

Move the highlight bar (arrow) to "TUNER SET" by pressing **CH▲▼** or **SHUTTLE PLUS▲▽**, then press **OK** or **SHUTTLE PLUS ▷**.

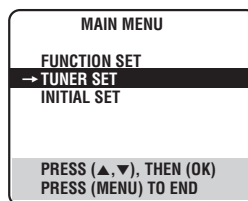

4 PERFORM AUTO CHANNEL SET

Move the highlight bar (arrow) to "AUTO CHANNEL SET" by pressing **CH▲▼** or **SHUTTLE PLUS▲▽**, then press **OK** or **SHUTTLE PLUS ▷**.

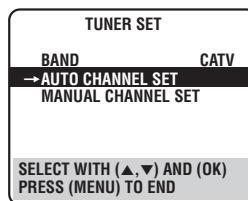

- Receivable channels in your area are automatically assigned to the **CH▲▼** (+/-) buttons, and non-receivable channels are skipped.

NOTES:

- At the end of Auto Channel Set, "SCAN COMPLETED" appears on screen.
- If the scan was unsuccessful, "SCAN COMPLETED -NO SIGNAL-" appears on screen. Check the connections and start again.

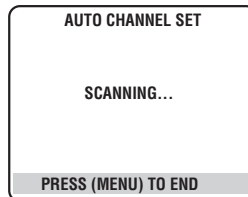

5 RETURN TO NORMAL SCREEN

Press **MENU**.

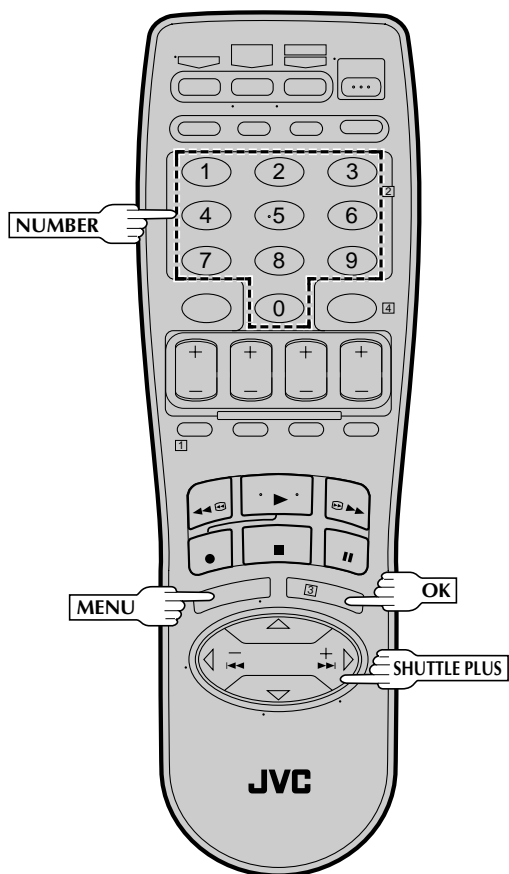
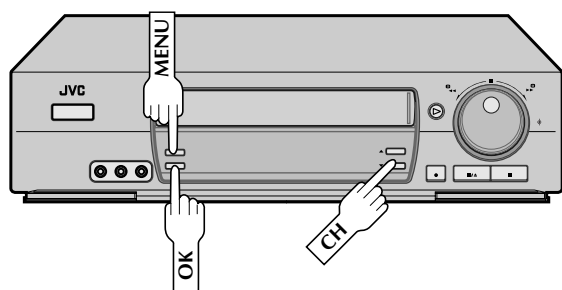

Add Or Delete A Channel

1

ACCESS MAIN MENU SCREEN

Press **MENU**.

2

ACCESS TUNER SET SCREEN

Move the highlight bar (arrow) to "TUNER SET" by pressing **CH▲▼** or **SHUTTLE PLUS▲▼**, then press **OK** or **SHUTTLE PLUS▷**.

3

ACCESS MANUAL CHANNEL SET SCREEN

Move the highlight bar (arrow) to "MANUAL CHANNEL SET" by pressing **CH▲▼** or **SHUTTLE PLUS▲▼**, then press **OK** or **SHUTTLE PLUS▷**.

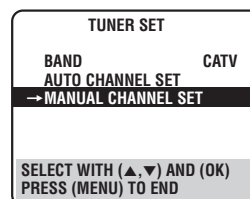

4

ADD OR SKIP DESIRED CHANNEL

Input the channel number using the **NUMBER** keys or by pressing **CH▲▼** or **SHUTTLE PLUS▲▼**, then press **OK** or **SHUTTLE PLUS▷** to set to "ADD" or "SKIP" as required. Repeat for each channel you want to add or skip.

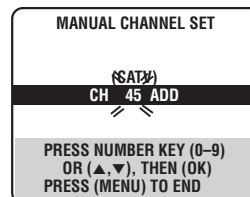

5

RETURN TO NORMAL SCREEN

Press **MENU**.

Cable Box Control

Suggested Location

Place the cable box on top of the VCR. Attach the VCR's Controller to the top of the VCR with the Controller's transmitter pointed towards the cable box's remote sensor.

Attention:

The Controller can also control a DBS receiver. If both a cable box and a DBS receiver are used, position the controller so its signal reaches the remote control sensors of both the cable box and DBS receiver.

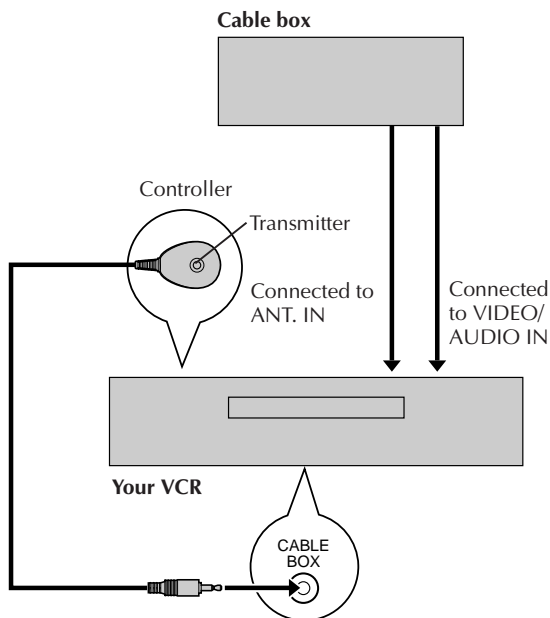
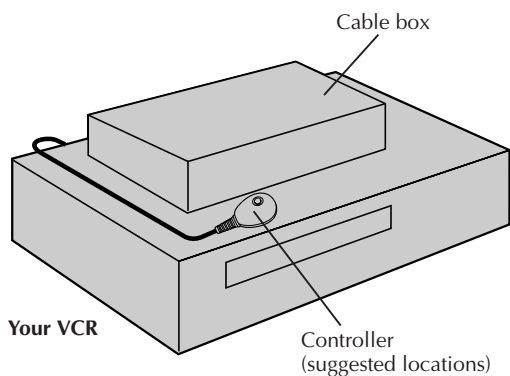

This procedure is required if you receive your TV channels through a cable box (descrambler). The Controller allows the VCR to automatically switch the cable box channel during timer-recording. The Controller is effective for recording shows that have been programmed using VCR Plus+ (pg. 36) or Express Timer Programming (pg. 40).

Situate And Connect Controller

1 SITUATE CONTROLLER

Place the Controller so that the path between its transmitter and the cable box's remote sensor is unobstructed.

2 ATTACH CONTROLLER

Fasten securely using the supplied adhesive strip.

3 CONNECT CABLE BOX TO VCR

The connection method depends on the type of cable box you have.

If your cable box has AUDIO and VIDEO OUT connectors . . .

. . . connect them to the AUDIO and VIDEO IN connectors on your VCR. Set the VCR to channel "L-1" for the rear AUDIO and VIDEO IN connectors, or channel "F-1" for the front AUDIO and VIDEO IN connectors to use the cable box.

If your cable box doesn't have AUDIO and VIDEO OUT connectors . . .

. . . connect the antenna output connector on the cable box to the ANT. IN connector on the rear of your VCR. Set the VCR tuner to the same channel as the cable box RF output (see page 17 also).

NOTE:

When connecting your cable box refer to its instruction manual.

4 CONNECT CONTROLLER TO VCR

Connect to the CABLE BOX connector on your VCR.

About Your Cable Box

This VCR has two separate methods to control your Cable Box.

- The VCR's Wireless Remote Control Unit can control your Cable Box. This eliminates the need for a separate Cable Box Remote Control Unit.
- The VCR's Controller can also control your Cable Box. This allows the VCR to change your Cable Box's channel number during timer recording.

Each method must be set up separately. To set up the VCR's Remote Control unit, refer to page 49. To set up the Controller go to page 17.

Turn on the TV and select the VCR channel 3 or 4 (or AV mode).

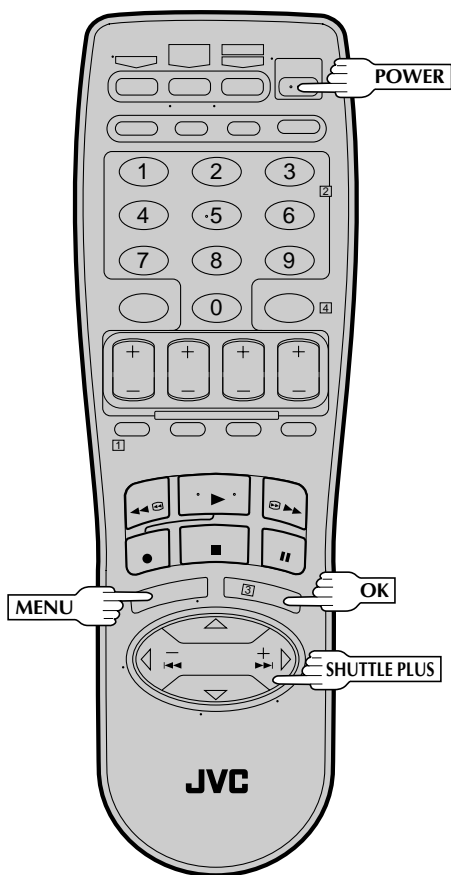
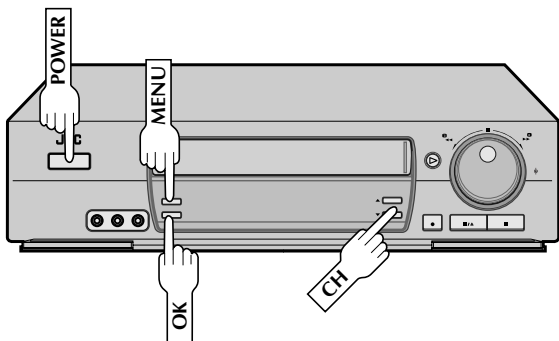

Set Cable Box Output Channel & Cable Box Brand

1 TURN ON CABLE BOX

Select a channel other than channel 9 on your cable box.

2 TURN ON THE VCR

Press **POWER**.

3 ACCESS MAIN MENU SCREEN

Press **MENU**.

4 ACCESS INITIAL SET SCREEN

Press **CH▲▼** or **SHUTTLE PLUS▲▼** to move the highlight bar (arrow) to "INITIAL SET", then press **OK** or **SHUTTLE PLUS ▷**.

5 ACCESS CABLE BOX SET SCREEN

Press **CH▲▼** or **SHUTTLE PLUS▲▼** to move the highlight bar (arrow) to "CABLE BOX SET", then press **OK** or **SHUTTLE PLUS ▷**.

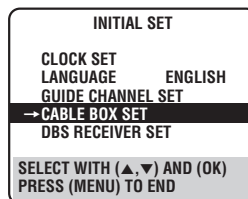

6 SELECT CABLE BOX OUTPUT CHANNEL

Your selection depends on how your cable box is connected to your VCR.

If your cable box is connected to your VCR using an RF connection . . .

. . . press **CH ▲▼** or **SHUTTLE PLUS ▲▼** until the channel number representing the cable box's output (CH2 – CH9) appears on the screen.

If your cable box is connected to your VCR's FRONT AUDIO/VIDEO IN connectors . . .

. . . press **CH ▲▼** or **SHUTTLE PLUS ▲▼** until "ON F-1 (FRONT)" appears on the screen.

If your cable box is connected to your VCR's REAR AUDIO/VIDEO IN connectors . . .

. . . press **CH ▲▼** or **SHUTTLE PLUS ▲▼** until "ON L-1 (REAR)" appears on the screen.

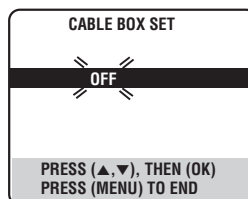

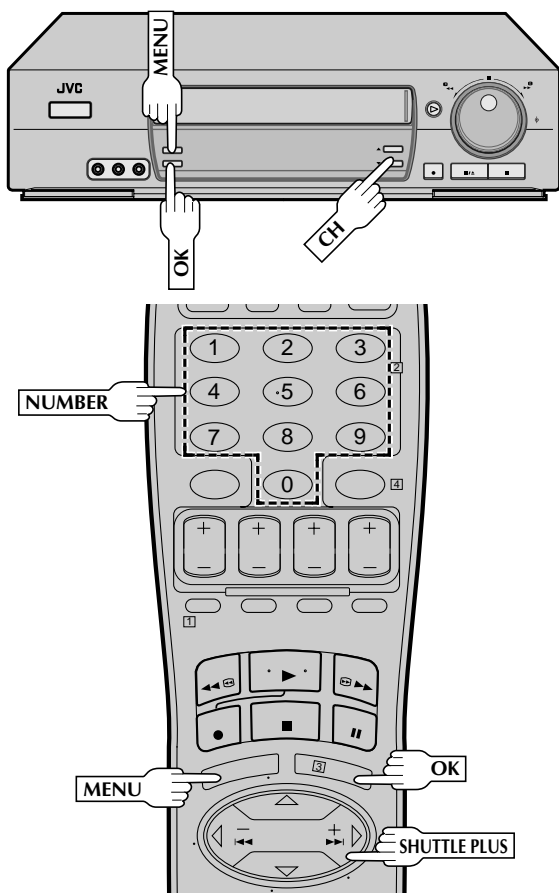

INFORMATION

When the VCR's clock has not been set (with AUTO CLOCK set to ON), if you press **OK** in step 7, "CABLE BOX USERS SET CLOCK MANUALLY" will be displayed on the screen for about 5 seconds, then the Clock Set screen will appear; perform the manual clock setting procedure on page 13. If you press **MENU** after the clock has been set, the Cable Box Brand Set screen appears.

NOTES:

- Although the supplied Controller is compatible with many different cable box brands, it is possible that it will not work with your cable box.
- If your cable box doesn't respond to any code between 1 and 25, you can't use the Controller to change cable box channels. In this case, make sure to leave the cable box turned on and tuned to the proper channel before the scheduled start of timer recording. Please contact your cable company about the possibility of exchanging your current cable box with one that is compatible with your VCR.
- The VCR can only change the cable box channel through the Controller during timer recording.
- If your cable box is one that can't be operated with a remote control (because it has no remote sensor), you can't use the Controller to change its channels. Make sure to leave the cable box turned on and tuned to the proper channel before the scheduled start of timer recording.
- **For customers in U.S.A.:** If you are unable to set the Controller, please contact JVC toll free at 1-800-252-5722.

ACCESS CABLE BOX BRAND SET SCREEN

Press **OK**.

ENTER CABLE BOX BRAND

Press the appropriate **NUMBER** keys to enter the Cable Box Code from the CABLE BOX BRAND LIST shown below, then press **OK**.

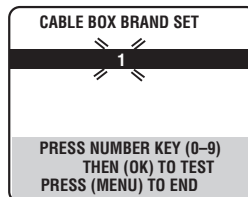

- If the cable box's channel changes to 9, setting is complete. Press **OK** and "CABLE BOX CONTROL IS ON" appears on the screen for about 5 seconds, then it returns to the normal screen.
- If the cable box's channel does not change to 9, press **CH ▲▼** or **SHUTTLE PLUS ▲▽** to move the highlight bar (arrow) to "NO", then press **OK**. By entering another code, repeat step 8 until the cable box's channel changes to 9.
- If the channel does not change after going through all the code numbers listed for your model of cable box, then try all the other numbers between 1 and 25.

CABLE BOX BRAND LIST

BRAND	CODE
ARCHER	1, 5, 17
CABLETENNA	1, 17
CABLEVIEW	15, 16, 17, 21, 25
CITIZEN	15, 16, 17, 21, 25
CURTIS	2, 8
DIAMOND	1, 17
EASTERN	19
GC BRAND	15, 16, 17, 21, 25
GEMINI	15
GENERAL INSTRUMENTS	1, 4, 6, 11, 12, 15
HAMLIN	10, 18, 19, 23
JASCO	15
JERROLD	1, 4, 6, 11, 12, 15
NOVAVISION	2, 8
OAK	7, 20
PANASONIC	13, 14
PULSER	15, 16, 17, 21, 25
RCA	13, 14
REGAL	10, 18, 19, 23
REGENCY	19
REMBRANDT	1, 16, 17
SAMSUNG	5, 16, 24
SCIENTIFIC ATLANTA	2, 8
SIGMA	7, 20
SL MARX	5, 16, 17, 24, 25
SPRUCER	13, 14
STARGATE	5, 15, 16, 17, 21, 24, 25
TELEVIEW	5, 16, 24
TOCOM	1, 4, 16
UNIKA	1, 17
UNIVERSAL	16, 17, 25
VIDEOWAY	3, 9, 22
ZENITH	3, 9, 22

DBS Receiver Control

Suggested Location

Place the DBS (Direct Broadcast Satellite) receiver on top of the VCR. Attach the VCR's Controller to the top of the VCR with the Controller's transmitter pointed towards the DBS receiver's remote sensor.

Attention:

The Controller can also control a cable box. If both a DBS receiver and a cable box are used, position the controller so its signal reaches the remote control sensors of both the DBS receiver and cable box.

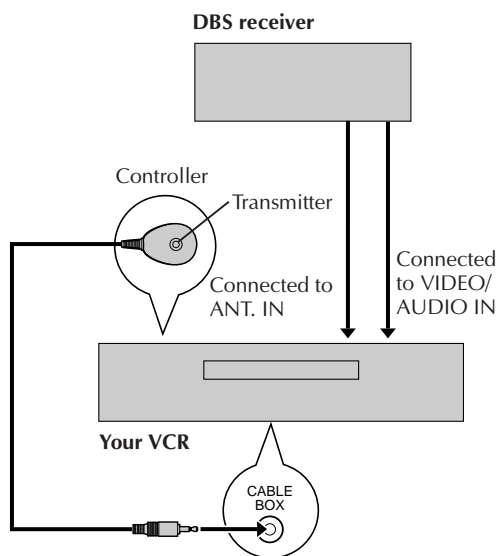
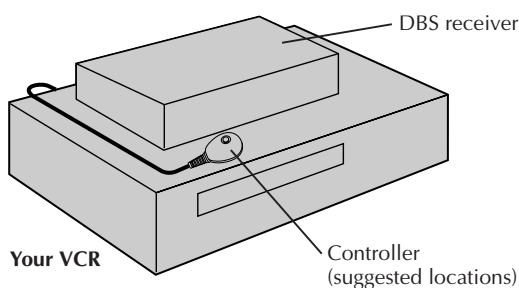

About Your DBS Receiver

This VCR has two separate methods to control your DBS Receiver.

- The VCR's Wireless Remote Control Unit can control your DBS Receiver. This eliminates the need for a separate DBS Receiver Remote Control Unit.
- The VCR's Controller can also control your DBS Receiver. This allows the VCR to change your DBS receiver's channel number during timer recording.

Each method must be set up separately. To set up the VCR's Remote Control unit, refer to page 50. To set up the Controller go to page 20.

The following procedure is required if you receive satellite channels through a DBS (Direct Broadcast Satellite) Receiver. The Controller allows the VCR to automatically switch the DBS Receiver's channels during timer recording.

NOTES:

- The VCR can automatically change the DBS Receiver channels using the controller when the VCR has been programmed using Express Timer Programming (see pg. 40). Because satellite programming does not use PlusCode; the Controller can not change the DBS Receiver channels during VCR Plus+ Timer Recording.
- If a cable box is also used it is recommended that you connect the DBS receiver to your VCR's A/V inputs and the cable box to your VCR's antenna input.

Situate And Connect Controller

1 SITUATE CONTROLLER

Place the Controller so that the path between its transmitter and the DBS receiver's remote sensor is unobstructed.

2 ATTACH CONTROLLER

Fasten securely using the supplied adhesive strips.

3 CONNECT DBS RECEIVER TO VCR

The connection method depends on the type of DBS receiver you have.

If your DBS receiver has AUDIO and VIDEO OUT connectors . . .

. . . connect them to the AUDIO and VIDEO IN connectors on your VCR. Set the VCR to channel "L-1" for the rear AUDIO and VIDEO IN connectors, or channel "F-1" for the front AUDIO and VIDEO IN connectors to use the DBS receiver.

If your DBS receiver doesn't have AUDIO and VIDEO OUT connectors . . .

. . . connect the antenna output connector on the DBS receiver to the ANT. IN connector on the rear of your VCR.

Set the VCR's tuner to the same channel as the DBS receiver's RF output. (See page 20 also.)

NOTE:

When connecting your DBS receiver refer to its instruction manual.

4 CONNECT CONTROLLER TO VCR

Connect to the CABLE BOX connector on your VCR.

Turn on the TV and select the VCR channel 3 or 4 (or AV mode).

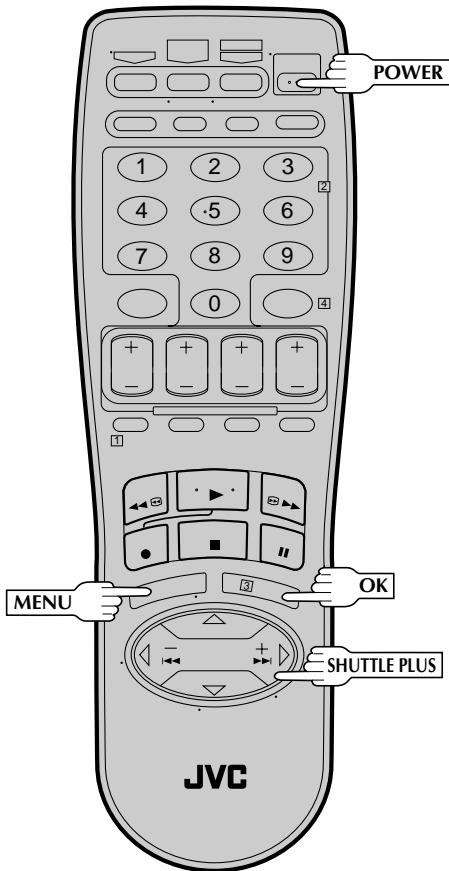
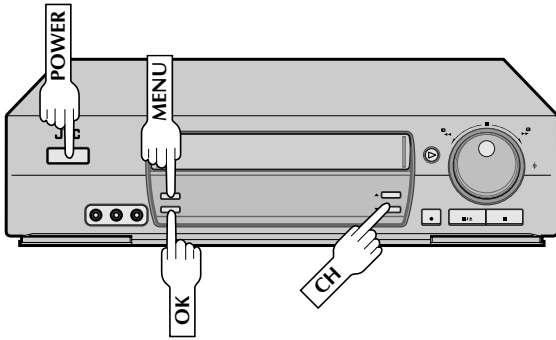

Set DBS Receiver Output Channel & DBS Receiver Brand

1 TURN ON DBS RECEIVER

Select a channel other than channel 55, 100 or 205 on your DBS receiver.

2 TURN ON THE VCR

Press **POWER**.

- Set the VCR to the channel (3 or 4 or F-1 or L-1) on which the signals from the DBS receiver are received.

3 ACCESS MAIN MENU SCREEN

Press **MENU**.

4 ACCESS INITIAL SET SCREEN

Press **CH▲▼** or **SHUTTLE PLUS▲▼** to move the highlight bar (arrow) to "INITIAL SET", then press **OK** or **SHUTTLE PLUS ▷**.

5 ACCESS DBS RECEIVER SET SCREEN

Press **CH▲▼** or **SHUTTLE PLUS▲▼** to move the highlight bar (arrow) to "DBS RECEIVER SET", then press **OK** or **SHUTTLE PLUS ▷**.

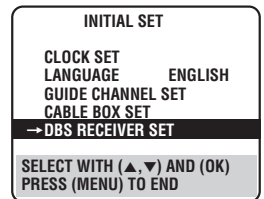

6 SELECT DBS RECEIVER OUTPUT CHANNEL

Your selection depends on how your DBS receiver is connected to your VCR.

If your DBS receiver is connected to your VCR using an RF connection . . .

. . . press **CH ▲▼** or **SHUTTLE PLUS ▲▼** until the channel number representing the DBS receiver's output (CH3 – CH4) appears on the screen.

If your DBS receiver is connected to your VCR's FRONT AUDIO/VIDEO IN connectors . . .

. . . press **CH ▲▼** or **SHUTTLE PLUS ▲▼** until "ON F-1 (FRONT)" appears on the screen.

If your DBS receiver is connected to your VCR's REAR AUDIO/VIDEO IN connectors . . .

. . . press **CH ▲▼** or **SHUTTLE PLUS ▲▼** until "ON L-1 (REAR)" appears on the screen.

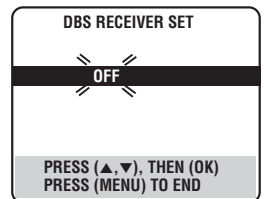

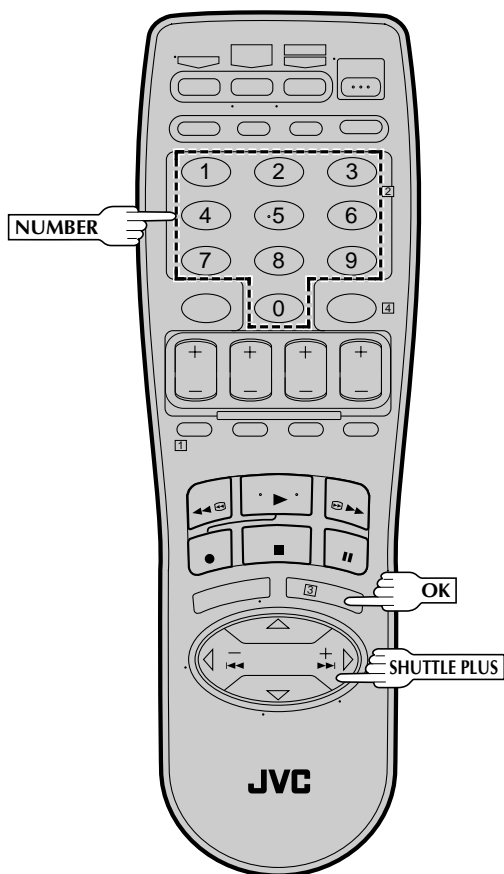
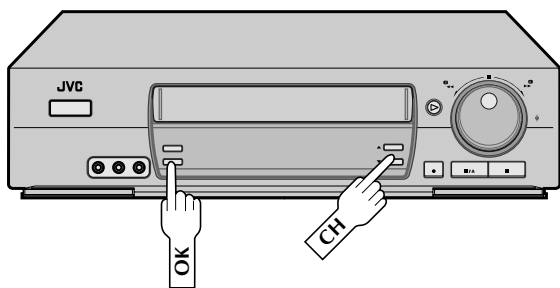

ACCESS DBS RECEIVER BRAND SET SCREEN

Press **OK**.

SET DBS RECEIVER BRAND

Press the appropriate **NUMBER** keys to enter the DBS Receiver Code from the following list, then press **OK**.

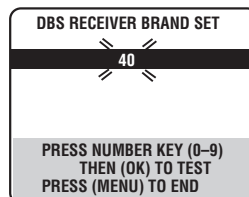

BRAND	CODE
JVC (DISH Network)	51
ECHOSTAR (DISH Network)	51
PRIMESTAR	50
SONY (DSS)	41
RCA (DSS)	40

- After **OK** is pressed, the program currently received through the DBS receiver will appear for about 10 seconds.
- If the DBS receiver's channel changes as follows, setting is complete. Press **OK** and "DBS RECEIVER CONTROL IS ON" appears on the screen for about 5 seconds, then it returns to the normal screen.
 - JVC → 100
 - ECHOSTAR → 100
 - PRIMESTAR → 55
 - SONY → 205
 - RCA → 205
- If the DBS receiver's channel does not change as shown above, press **CH ▲▼** or **SHUTTLE PLUS ▲▼** to move the highlight bar (arrow) to "NO", then press **OK**. Re-enter the correct code.

NOTES:

- It is possible that the Controller will not work with all types of DBS receiver.
- If your DBS receiver doesn't respond to the code, you can't use the Controller to change satellite channels. In this case, make sure to leave the DBS receiver turned on and tuned to the proper channel before the scheduled start of timer recording.
- The VCR can only change the satellite channel through the Controller during timer recording.
- If your DBS receiver is one that can't be operated with a remote control (because it has no remote sensor), you can't use the Controller to change its channels. Make sure to leave the DBS receiver turned on and tuned to the proper channel before the scheduled start of timer recording.
- **For customers in U.S.A.:** If you are unable to set the Controller, please contact JVC toll free at 1-800-252-5722.

Simple Playback

Turn on the TV and select the VCR channel 3 or 4 (or AV mode).

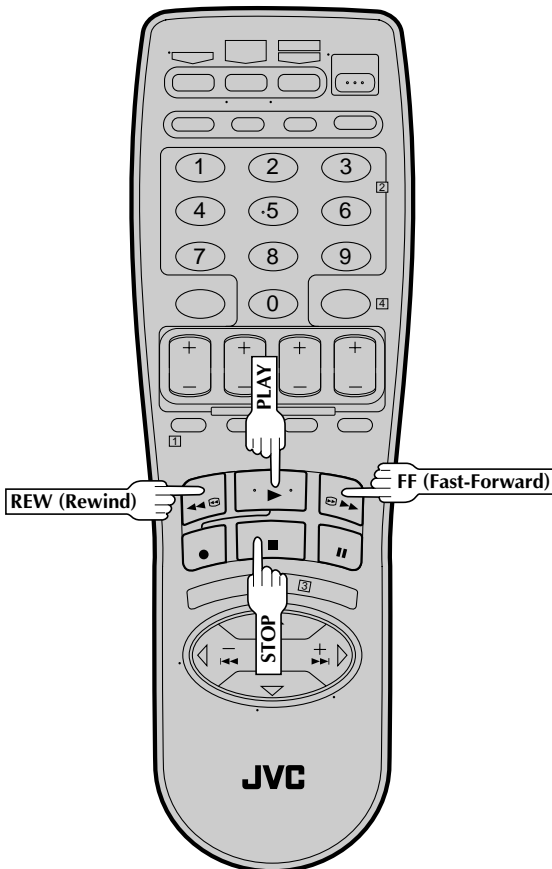
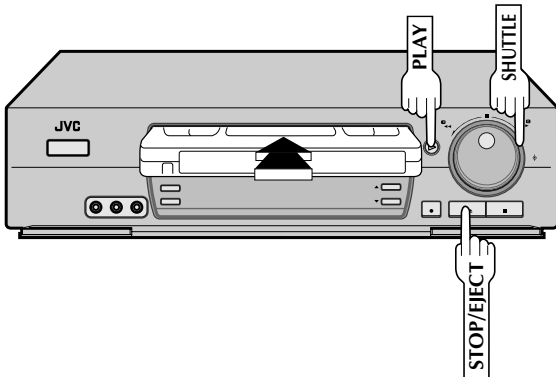

1 LOAD A CASSETTE

Make sure the window side is up, the rear label side is facing you and the arrow on the front of the cassette is pointing towards the VCR. Don't apply too much pressure when inserting.

- The VCR's power comes on automatically.
- The counter is automatically reset to "0:00:00".
- If the cassette's record safety tab has been removed, playback begins automatically.

2 FIND PROGRAM START POINT

If the tape is advanced past the start point, press **REW** or turn **SHUTTLE** ring to the left. To go forward, press **FF** or turn **SHUTTLE** ring to the right.

3 START PLAYBACK

Press **PLAY**. "VIDEO CALIBRATION" appears on the screen (when VIDEO CALIBRATION is set to "ON" [pg. 32](#)).

4 STOP PLAYBACK

Press **STOP** or **STOP/EJECT**. Then press **STOP/EJECT** to remove the cassette.

INFORMATION

This video recorder is equipped with SQPB (S-VHS QUASI PLAYBACK) that lets you watch tapes recorded in the S-VHS format with regular VHS resolution.

- SQPB does not deliver Super VHS resolution.
- S-VHS recording is not possible with this video recorder.

Usable cassettes

Full-Size VHS
T-30 (ST-30**)
T-60 (ST-60**)
T-90
T-120 (ST-120**)
T-160 (ST-160**)
ST-210**

Compact VHS*
TC-20 (ST-C20**)
TC-30 (ST-C30**)
TC-40 (ST-C40**)

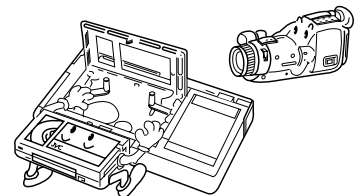

* Compact VHS camcorder recordings can be played on this video recorder. Simply place the recorded cassette into a VHS Cassette Adapter and it can be used just like any full-sized VHS cassette.

** This video recorder can record on regular VHS and Super VHS cassettes. However, it will record regular VHS signals only.

Simple Recording

Turn on the TV and select the VCR channel 3 or 4 (or AV mode).

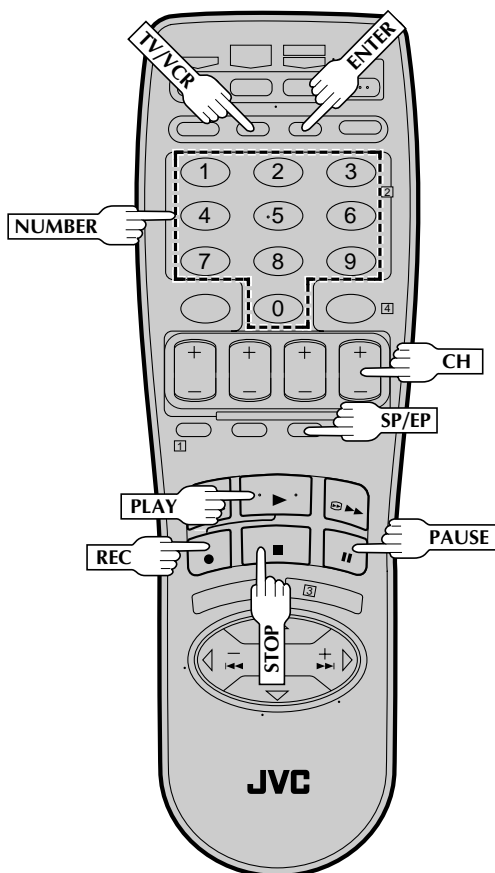
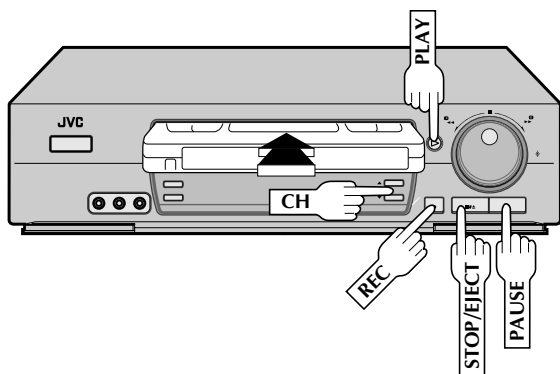

1 LOAD A CASSETTE

Make sure the record safety tab is intact. If not, cover the hole with adhesive tape before inserting the cassette.

2 SELECT RECORDING CHANNEL

Press **CH▲▼** (+/-). Or press the appropriate **NUMBER** keys, then press **ENTER**. (The channel changes after a few seconds whether you press **ENTER** or not.)

- If you use the RF connection, by pressing the **TV/VCR** button, select VCR mode to view the program to be recorded.

3 SET TAPE SPEED

Press **SP/EP** to set the recording speed.

4 START RECORDING

Press and hold **REC** and press **PLAY** on the remote control, or press **REC** on the VCR's front panel.

Video Calibration takes place at the beginning of both the first SP and the first EP recording after inserting the cassette (when video calibration is set to "ON"  pg. 32).

5 PAUSE/RESUME RECORDING

Press **PAUSE**. Press **PLAY** to resume recording.

- During record pause, you can change the recording channel by using the **CH▲▼** (+/-) buttons or **NUMBER** keys.

Video Calibration will not take place if the tape speed is changed while in record pause mode.

6 STOP RECORDING

Press **STOP** or **STOP/EJECT**. Then press **STOP/EJECT** to remove the cassette.

Accidental erasure prevention

- To prevent accidental recording on a recorded cassette, remove its record safety tab. To record on it later, cover the hole with adhesive tape.

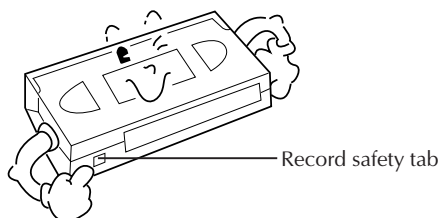

Playback Features

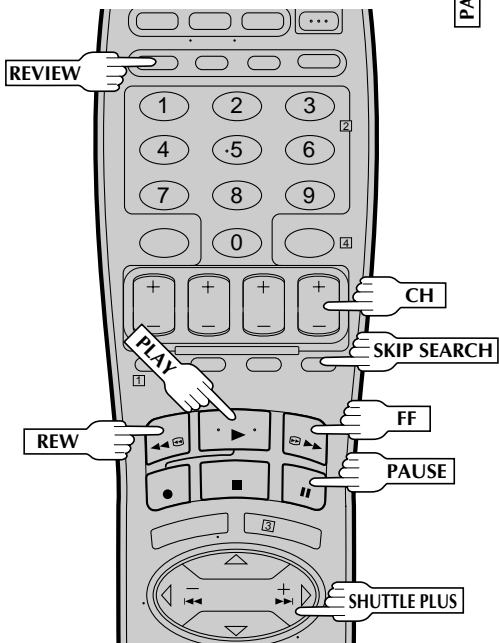
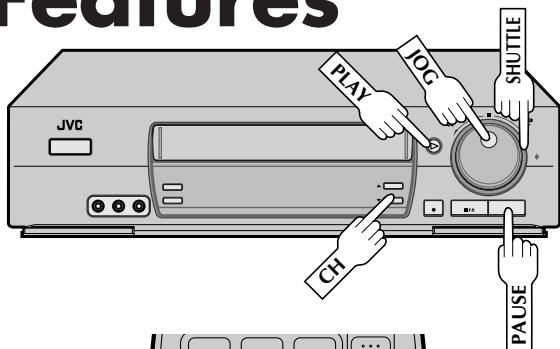

Variable-Speed Search/Reverse Motion Playback

1 ACTIVATE VARIABLE-SPEED SEARCH

During playback or still, turn the **SHUTTLE** ring to the right for forward variable-speed search, or to the left for reverse variable-speed search.

OR

During playback, repeatedly press and release **SHUTTLE PLUS** ◀◀ or ▶▶ to select the search speed.

- To increase the speed in the forward direction, press and release ▶▶ repeatedly to select the various forward search modes.
- To decrease the speed in the forward direction, press and release ◀◀.
- To play in reverse slow motion, and in reverse play mode, continue to press ◀◀ repeatedly after selecting all the forward slow motion modes.

To resume normal playback, press **PLAY**.

Still Picture/Frame-By-Frame Playback

1 PAUSE DURING PLAYBACK

Press **PAUSE**. If there is vertical jitter, use the **CH** ▲ (+) or ▼ (-) button to correct the picture.

2 ACTIVATE FRAME-BY-FRAME PLAYBACK

Turn the **JOG** dial to the right for forward frame-by-frame playback, or to the left for reverse frame-by-frame playback.

OR

Press **PAUSE** repeatedly to advance one frame at a time.

OR

Press **SHUTTLE PLUS** ▶▶ repeatedly for forward frame-by-frame playback or **SHUTTLE PLUS** ◀◀ repeatedly for reverse frame-by-frame playback.

To resume normal playback, press **PLAY**.

Slow Motion/Reverse Slow Motion

1 ACTIVATE SLOW-MOTION PLAYBACK

For hands-free slow-motion, press and release **SHUTTLE PLUS** ◀◀ during playback to decrease speed in the forward direction. Continue to press and release **SHUTTLE PLUS** ◀◀ to select the reverse slow motion, reverse play and reverse search modes.

OR

During playback or still picture, turn the **SHUTTLE** ring to the right for forward slow motion, or to the left for reverse slow motion.

OR

During still picture, press and hold **SHUTTLE PLUS** ▶▶ for forward slow motion, or press and hold **SHUTTLE PLUS** ◀◀ for reverse slow motion. Release to return to still picture.

OR

For forward slow motion during still picture, press and hold **PAUSE** for more than 2 seconds. Press **PAUSE** again to return to still picture.

To resume normal playback, press **PLAY**.

NOTE: Refer to the following for the operations described on this page.

Shuttle Ring Modes

Forward search	: 3 steps
Normal playback	
Slow motion	: 2 steps
Reverse slow motion	: 2 steps
Reverse playback	
Reverse search	: 3 steps

Reverse			Forward		
Reverse search 3 steps	Reverse play	Reverse slow motion 2 steps	Slow motion 2 steps	Play	Forward search 4 steps

High-Speed Search

ACTIVATE HIGH-SPEED SEARCH

1 During playback or still, turn the **SHUTTLE** ring all the way to the right for forward high-speed search, or to the left for reverse high-speed search. By releasing **SHUTTLE** still picture playback is selected.

- For forward high-speed search, turn the **SHUTTLE** ring all the way to the right and release it within 1 second.
- For reverse high-speed search, turn the **SHUTTLE** ring all the way to the left and release it within 1 second.

OR

During playback or still, press **FF** for forward high-speed search, or **REW** for reverse high-speed search.

To resume normal playback, press **PLAY**.

NOTE:

For short searches, during playback or still, press and hold **FF** or **REW**. When released, normal playback resumes.

Skip Search

SKIP OVER UNWANTED SECTIONS

1 Press **SKIP SEARCH** 1 to 4 times during playback. Each press initiates a 30-second period of fast-motion playback. Normal playback resumes automatically.

NOTES:

- To return to normal playback during a Skip Search, press **PLAY**.
- If the Skip Menu screen appears, see page 30.

Index Search

Index codes are placed on the tape at the start of each recording. You can find and automatically play back from the start of any recording using the Index Search function.

START SEARCH

1 While the tape is stopped, press **SHUTTLE PLUS** ◀◀ or ▶▶ (◀or▶).

ACCESS DISTANT CODE

2 To access a recording 2–9 index codes away, press **SHUTTLE PLUS** ◀◀ or ▶▶ (◀or▶) repeatedly until the correct number is displayed on screen (only if **SUPERIMPOSE** is set to ON (ⓘ pg. 29)). Playback begins automatically when the desired recording is located.

- If necessary press **REW** or **FF** when play starts to search visually to find the very beginning of the desired program.

NOTE:

An index code is not placed on the tape when recording is paused and then resumed.

Instant ReView

At the press of a button, you can power up your VCR, rewind the tape and begin viewing the most recent timer-recorded program.

ACTIVATE INSTANT REVIEW

1 After ensuring that the Timer mode is disengaged, press **REVIEW**.

- The power comes on and the VCR rewinds to the index code indicating the start of the last timer-recorded program, then begins playback automatically.
- You can access a program 2–9 index codes away from the current position on the tape. If, for example, you have 5 programs recorded and you want to watch the third one, press **REVIEW** three times.
- If necessary press **REW** or **FF** when play starts to search visually to find the very beginning of the desired program.
- If the tape is already rewound when **REVIEW** is pressed, it will play the tape from the beginning. It will not fast forward to an index code.
- The Instant Review function will also operate if the VCR's power is on.

Manual Tracking

Once playback begins, the VCR's automatic tracking function is engaged. If tracking noise appears in the picture, you can override this and make the adjustment manually.

ENGAGE MANUAL TRACKING MODE

1 During playback, press the **CH▲** and **▼** buttons on the VCR's front panel simultaneously to cancel the automatic tracking mode and enable manual tracking adjust.

ADJUST MANUAL TRACKING

2 Press **CH▲** (+) or **▼** (–) on the VCR's front panel or remote. Press briefly for fine adjust, or press and hold for coarse adjust. Watch the screen and continue adjusting until optimum picture and sound quality are achieved.

RE-ENGAGE AUTOMATIC TRACKING

3 Press the **CH▲** and **▼** buttons on the VCR's front panel simultaneously.

- When automatic tracking is re-engaged, Video Calibration is automatically activated.

NOTES:

- To obtain a noiseless still picture it may be necessary to adjust tracking in slow playback and then engage Pause.
- Manual tracking is possible during hands-free slow-motion. During hands-free slow-motion playback, simply press **CH▲** (+) or **▼** (–) on the VCR's front panel or remote to adjust tracking.

Picture Control

This feature helps you to adjust the playback picture quality according to your preference. *The default setting is "AUTO."

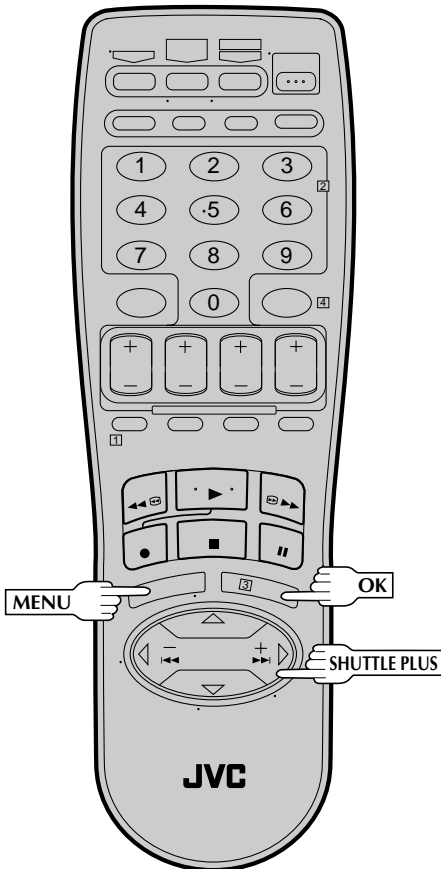
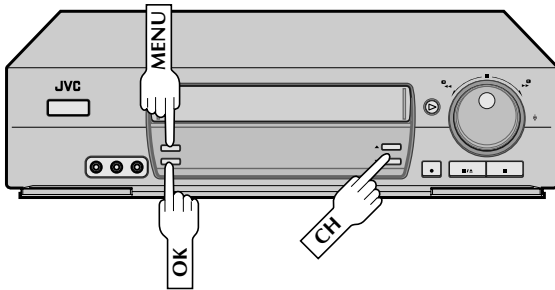

1 ACCESS MAIN MENU SCREEN

Press MENU.

2 ACCESS FUNCTION SET SCREEN

Move the highlight bar (arrow) to "FUNCTION SET" by pressing CH▲▼ or SHUTTLE PLUS▲▼, then press OK or SHUTTLE PLUS ▷.

3 SELECT PICTURE CONTROL SET MODE

Move the highlight bar (arrow) to "PICTURE CONTROL" by pressing CH▲▼ or SHUTTLE PLUS ▲▼, then press OK or SHUTTLE PLUS ▷ to select the desired mode.

AUTO*: Normally select AUTO.

It automatically adjust the picture quality.

* When VIDEO CALIBRATION is set to OFF (pg. 32), you can only select NORM instead of AUTO.

EDIT: Select when you dub tapes.

SOFT: Select when you want to soften the picture.

SHARP: Select when you want to sharpen the picture.

FUNCTION	
VIDEO CALIBRATION	ON
→ PICTURE CONTROL	AUTO
AUTO TIMER	OFF
SUPERIMPOSE	ON
AUTO SP→EP TIMER	OFF
NEXT PAGE	
SELECT WITH (▲, ▼) AND (OK)	
PRESS (MENU) TO END	

NOTE:

- When you select EDIT, SHARP or SOFT, the selected mode will not change until you select again.
- When you select EDIT to dub tapes, be sure to select AUTO (or NORM when VIDEO CALIBRATION is set to OFF) after you finish dubbing the tapes.

4 RETURN TO NORMAL SCREEN

Press MENU.

NOTE:

Select EDIT when you are dubbing tapes. Refer to page 45.

Select The Soundtrack

Your VCR can record two soundtracks simultaneously (Normal and Hi-Fi) and play back the selected one, or both together. Or, when viewing a pre-recorded tape that contains two separate Hi-Fi audio programs, you can choose to listen to either one by selecting either "Hi-Fi L" or "Hi-Fi R" in step 3.

- 1 **ACCESS MAIN MENU SCREEN**
Press **MENU**.
- 2 **ACCESS FUNCTION SET SCREEN**
Move the highlight bar (arrow) to "FUNCTION SET" by pressing **CH▲▼** or **SHUTTLE PLUS△▽**, then press **OK** or **SHUTTLE PLUS ▷**.
- 3 **SELECT AUDIO MONITOR SET MODE**
Move the highlight bar (arrow) to "AUDIO MONITOR" by pressing **CH▲▼** or **SHUTTLE PLUS △▽**, then press **OK** or **SHUTTLE PLUS ▷** to select the desired mode:
a- Hi-Fi
b- Hi-Fi L
c- Hi-Fi R
d- Normal
e- Mix
- 4 **RETURN TO NORMAL SCREEN**
Press **MENU**.

FUNCTION	
→VIDEO CALIBRATION	ON
PICTURE CONTROL	AUTO
AUTO TIMER	OFF
SUPERIMPOSE	ON
AUTO SP→EP TIMER	OFF
NEXT PAGE	
SELECT WITH (▲,▼) AND (OK)	
PRESS (MENU) TO END	



PREVIOUS PAGE	
VIDEO STABILIZER	ON
2ND AUDIO RECORD	OFF
→AUDIO MONITOR	HI-FI
AV COMPU-LINK	ON
SELECT WITH (▲,▼) AND (OK)	
PRESS (MENU) TO END	

NOTES:

- If the tape being played back has no Hi-Fi soundtrack, the Normal soundtrack will be heard no matter what choice you make in step 3.
- If RF connection is used for TV, even if Hi-Fi audio monitor is selected the sound will be mono and will be reproduced in both loudspeakers.

Video Stabilizer

By activating the Video Stabilizer you can correct vertical vibrations in the picture when playing back unstable recordings that were made on another VCR. When this function is set to "ON", vertical vibration will be automatically corrected. *The default setting is "OFF".

- 1 **ACCESS MAIN MENU SCREEN**
Press **MENU**.
- 2 **ACCESS FUNCTION SET SCREEN**
Move the highlight bar (arrow) to "FUNCTION SET" by pressing **CH▲▼** or **SHUTTLE PLUS△▽**, then press **OK** or **SHUTTLE PLUS ▷**.
- 3 **ACTIVATE VIDEO STABILIZER**
Move the highlight bar (arrow) to "VIDEO STABILIZER" by pressing **CH▲▼** or **SHUTTLE PLUS △▽**, then press **OK** or **SHUTTLE PLUS ▷** to set to "ON".
- 4 **RETURN TO NORMAL SCREEN**
Press **MENU**.

MAIN MENU	
→FUNCTION SET	
TUNER SET	
INITIAL SET	
PRESS (▲,▼), THEN (OK)	
PRESS (MENU) TO END	

FUNCTION	
→VIDEO CALIBRATION	ON
PICTURE CONTROL	AUTO
AUTO TIMER	OFF
SUPERIMPOSE	ON
AUTO SP→EP TIMER	OFF
NEXT PAGE	
SELECT WITH (▲,▼) AND (OK)	
PRESS (MENU) TO END	



PREVIOUS PAGE	
→VIDEO STABILIZER	ON
2ND AUDIO RECORD	OFF
AUDIO MONITOR	HI-FI
AV COMPU-LINK	ON
SELECT WITH (▲,▼) AND (OK)	
PRESS (MENU) TO END	

NOTES:

- When you finish viewing the tape, be sure to set it back to "OFF".
- Regardless of the setting, this function has no effect during recording and during special-effects playback.
- The Superimpose mode indications may jitter vertically when "VIDEO STABILIZER" is set to "ON".
- To watch recordings with close-caption, it is necessary to set the Video Stabilizer function to "OFF".

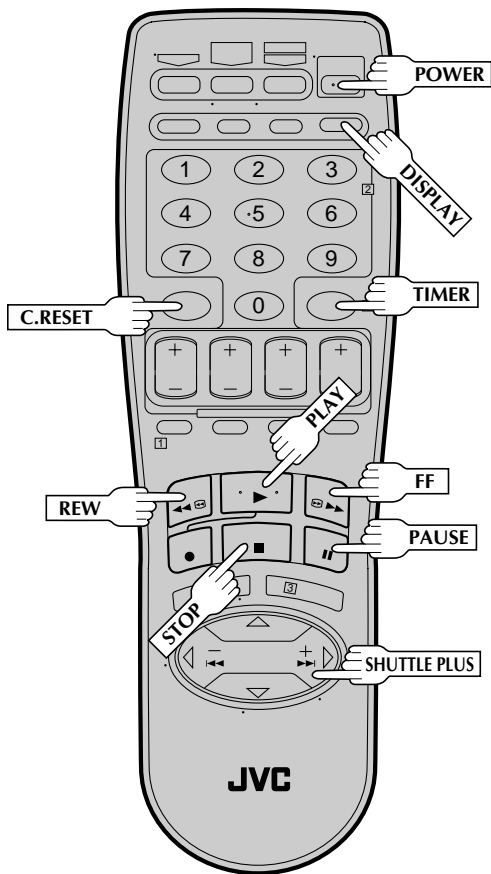
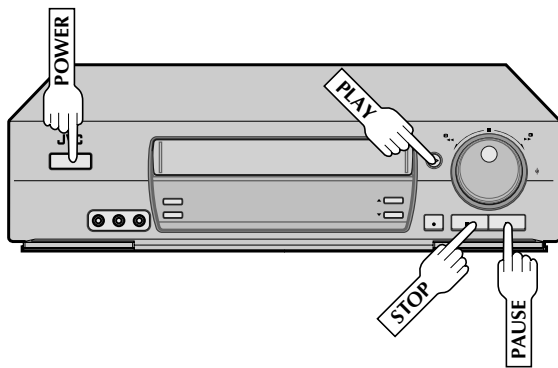

Repeat Playback

1

START REPEAT

Press and hold **PLAY** (until "▶" blinks on the front display panel) during playback, then release.



- The entire tape is played back 50 times.

2

STOP REPEAT

To stop, press **STOP** at any time.

NOTE:

Pressing **PLAY**, **REW**, **FF**, **PAUSE** or **SHUTTLE PLUS** ◀◀ or ▶▶ also stops Repeat Playback.

Counter Reset

1

RESET COUNTER TO ZERO

Press **C.RESET**.

NOTE:

By pressing the **DISPLAY** button, you can change the display to show the counter reading, channel number or clock time. (Channel number is not displayed during playback.)

Tape Position Indicator

The Tape position indicator appears on screen when, from the stop mode, you press **FF** or **REW**, or perform an Index Search or Instant ReView. The position of "■" in relation to "B" (Beginning) or "E" (End) shows you where you are on the tape.

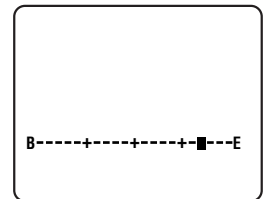

NOTES:

- "SUPERIMPOSE" must be set to "ON", or the indicator will not appear (☞ pg. 29).
- It may take a few seconds for the Tape Position Indicator to be displayed.

Next-Function Memory

The Next Function Memory "tells" the VCR what to do after rewinding. Before continuing, ensure that the VCR is in stop mode.

- a- For Automatic Start Of Playback After Tape Rewind . . .
 . . . press **REW**, then press **PLAY** within 2 seconds.
- b- For Automatic Power Off After Tape Rewind . . .
 . . . press **REW**, then press **POWER** within 2 seconds.
- c- For Automatic Timer Standby After Tape Rewind . . .
 . . . press **REW**, then press **TIMER** within 2 seconds.

NOTE:

It is not possible to select the Automatic Timer functions if the cassette's record safety tab is removed.

Superimpose

This function, switchable between ON and OFF, determines whether or not operational indicators will appear on screen.

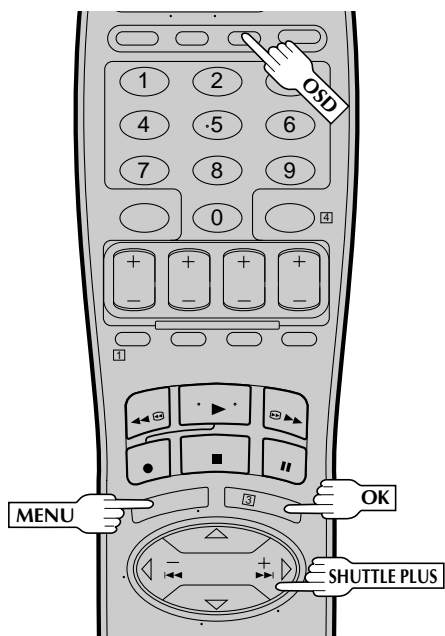
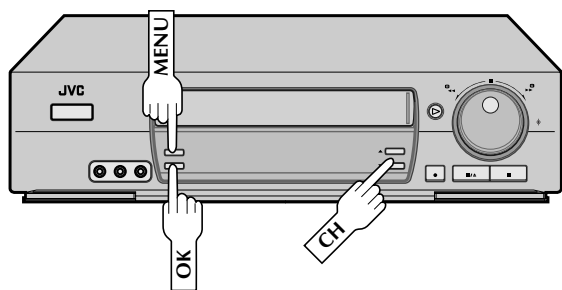

To recall an indication

- 1 Press **OSD**.
 - All indications corresponding to the current status are displayed for 5 seconds. After that, the counter information and RECORD/PAUSE if in the Record Pause mode, are left displayed on the screen.
- 2 Press **OSD** again to clear the display.
 - The RECORD/PAUSE indication is left displayed on the screen.

The superimposed indication on the TV screen tells you what the VCR is doing.

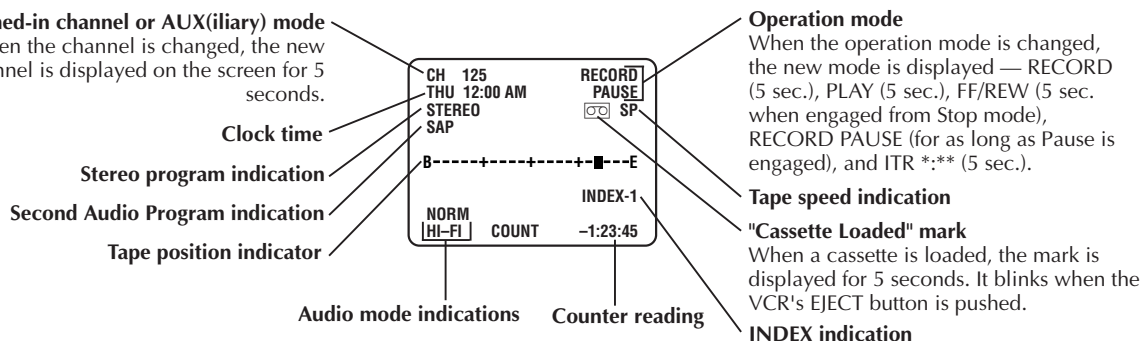

1 ACCESS MAIN MENU SCREEN

Press **MENU**.

2 ACCESS FUNCTION SET SCREEN

Move the highlight bar (arrow) to "FUNCTION SET" by pressing **CH▲▼** or **SHUTTLE PLUS▲▼**, then press **OK** or **SHUTTLE PLUS▷**.

3 SELECT SUPERIMPOSE SET MODE

Move the highlight bar (arrow) to "SUPERIMPOSE" by pressing **CH▲▼** or **SHUTTLE PLUS▲▼**, then press **OK** or **SHUTTLE PLUS▷** to select the desired mode:

FUNCTION	
VIDEO CALIBRATION	ON
PICTURE CONTROL	AUTO
AUTO TIMER	OFF
→ SUPERIMPOSE	ON
AUTO SP→EP TIMER	OFF
NEXT PAGE	
SELECT WITH (▲,▼) AND (OK)	
PRESS (MENU) TO END	

- a- Select "ON" if you want the superimposed operational indications on the TV screen.
- b- Select "OFF" if you do not want the superimposed operational indications on the screen.

4 RETURN TO NORMAL SCREEN

Press **MENU**.

NOTES:

- If you engage the Record Pause mode, RECORD/PAUSE is displayed regardless of the Superimpose mode setting.
- If you select a channel on which no signal is received, the channel number is displayed regardless of the Superimpose mode setting.

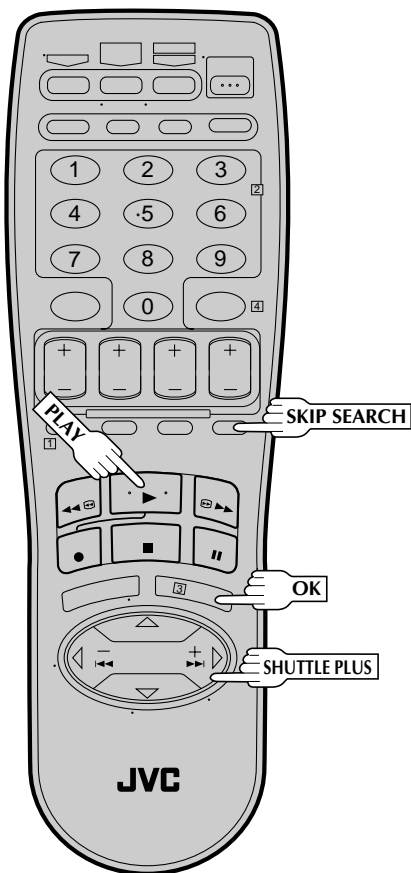

ATTENTION

Movie Advance works only on prerecorded cassettes that have been recorded in the SP mode, and have no safety tab. If the VCR detects the EP mode after you press **OK** in step 4, the following screen appears.

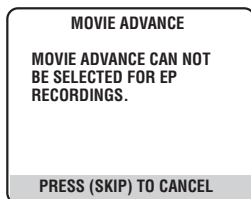

NOTES:

- Normally there is a period of black and no audio at the beginning and end of previews. The Movie Advance feature detects those parts where the picture fades to black and the audio fades to silence, and initiates fast-motion to skip over the detected previews.
- Some previews may not be detected and Movie Advance may not work properly.
- The setting you selected in step 3 remains in effect until the cassette is ejected.

Movie Advance

This feature helps you locate certain parts of prerecorded movies (rented or purchased) and works in two ways.

- You can go to the beginning of the movie, skipping over all previews.
- You can fast-motion the tape to the beginning of the next preview, so you can skip over previews one by one.

1 LOAD A CASSETTE

Insert a cassette that has a prerecorded movie (rented or purchased), with no safety tab, into the VCR. Playback begins automatically.

2 ACCESS SKIP MENU SCREEN

Press **SKIP SEARCH**.

3 SELECT MODE

Press **CH▲▼** or **SHUTTLE PLUS▲▽** to move the highlight bar (arrow) to your choice.

- a- Select "MOVIE ADVANCE" if you want to advance directly to the beginning of the movie.
- b- Select "MOVIE ADVANCE (PREVIEW)" if you want to advance to the next preview.
- c- Select "SKIP SEARCH" if you do not want to perform Movie Advance, then press **OK** and the VCR enters stop mode. To activate the Skip Search function, see page 25.

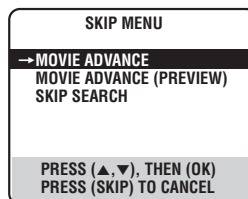

4 PERFORM MOVIE ADVANCE

- a- If you selected "MOVIE ADVANCE" in step 3 and press **OK**, the following screen will appear with a blue background. The VCR will rewind the beginning of the tape, then will fast-motion to the beginning of the movie. "READY" will appear and blink when the beginning of the movie is detected and the Stop mode will be engaged. Press **PLAY** to view the movie.

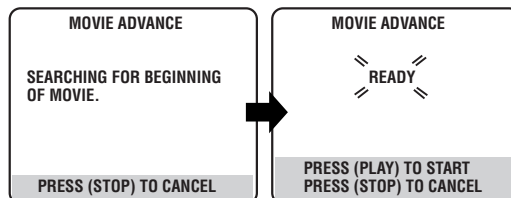

- b- If you selected "MOVIE ADVANCE (PREVIEW)" in step 3 and press **OK**, the VCR will fast-motion to the beginning of the next preview and normal playback will resume when it is detected. Each press of **SKIP SEARCH** fast-motions to the beginning of the next preview, thereby skipping over one preview each time.

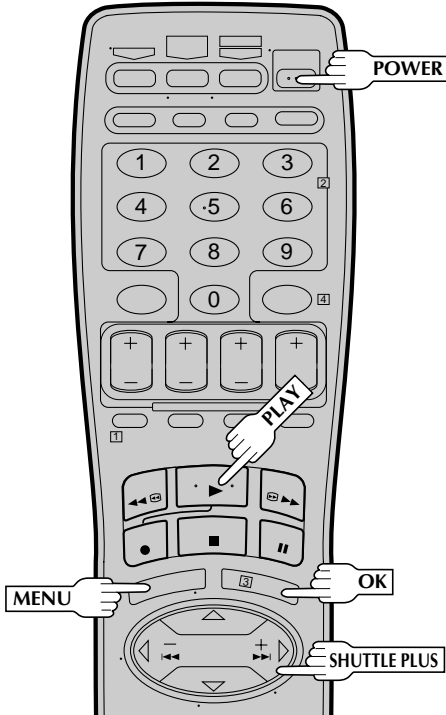
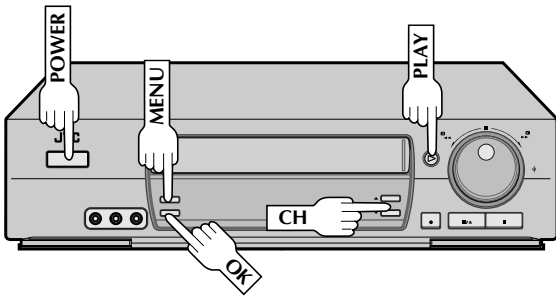

AV COMPU LINK Playback

Your VCR is compatible with JVC's AV COMPU LINK components, including amplifiers (or receivers) and televisions. AV COMPU LINK provides one touch control of the audio and video components that are linked via their AV COMPU LINK connectors.

For example: simply load a cassette in the VCR and press **PLAY** and the AV COMPU LINK components automatically power on, the TV's AV mode is selected and the VCR goes into play mode. (PLAY need not be pressed if the cassette's record safety tab is removed.)

Example

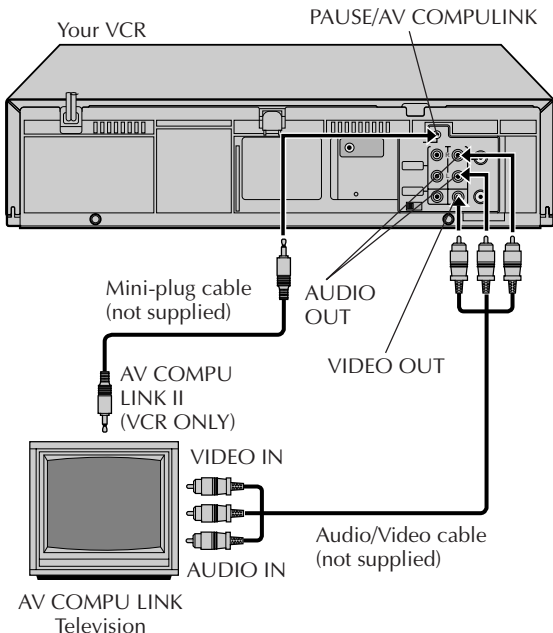

1 MAKE CONNECTION

Connect your VCR to an AV COMPU LINK component as shown in the illustration in the left column.

- The mini-plug cable is a mono 3.5 mm mini-plug to mono 3.5 mm mini-plug connector.

2 ACCESS MAIN MENU SCREEN

Press **MENU**.

3 ACCESS FUNCTION SET SCREEN

Press **CH▲▼** or **SHUTTLE PLUS▲▼** to move the highlight bar (arrow) to "FUNCTION SET", then press **OK** or **SHUTTLE PLUS▷**.

4 ENABLE AV COMPU LINK PLAYBACK

Press **CH▲▼** or **SHUTTLE PLUS▲▼** to move the highlight bar (arrow) to "AV COMPU-LINK", then press **OK** or **SHUTTLE PLUS▷** to set to "ON".

FUNCTION	
→VIDEO CALIBRATION	ON
PICTURE CONTROL	AUTO
AUTO TIMER	OFF
SUPERIMPOSE	ON
AUTO SP→EP TIMER	OFF
NEXT PAGE	
SELECT WITH (▲, ▼) AND (OK)	
PRESS (MENU) TO END	



PREVIOUS PAGE	
VIDEO STABILIZER	OFF
2ND AUDIO RECORD	OFF
AUDIO MONITOR	HI-FI
→AV COMPU-LINK	ON
SELECT WITH (▲, ▼) AND (OK)	
PRESS (MENU) TO END	

5 RETURN TO NORMAL SCREEN

Press **MENU**.

6 PERFORM AV COMPU LINK PLAYBACK

Simply insert a cassette and press **PLAY** (if the cassette's record safety tab has been removed, playback begins automatically). Linked components are turned on, and the TV set to its AV mode, automatically!

NOTE:

Connection varies depending on the type of JVC TV you have. Please refer to the TV's instruction manual when making this connection.

Active Video Calibration

Turn on the TV and select the VCR channel 3 or 4 (or AV mode).

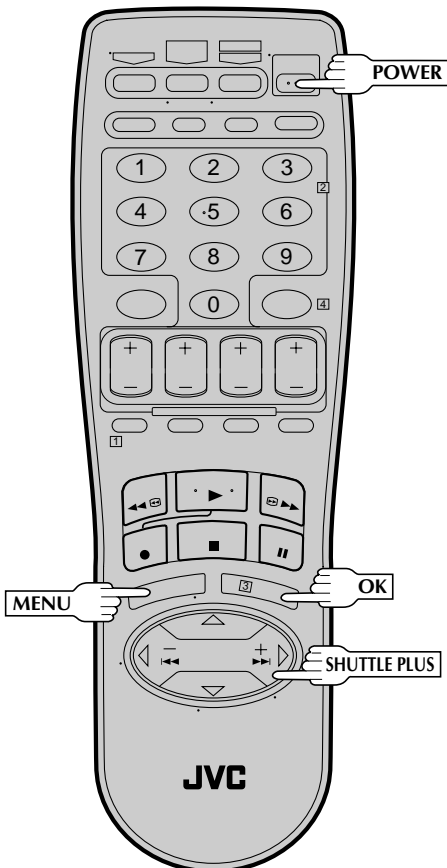
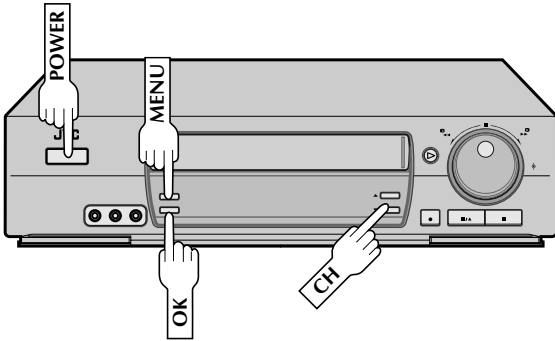

Active Video Calibration checks the condition of the tape during recording and playback, and compensates for poor reproduction to provide the best quality recording and playback pictures. *The default setting is "ON".

Preparation

1 TURN ON THE VCR

Press **POWER**.

2 ACCESS MAIN MENU SCREEN

Press **MENU**.

3 ACCESS FUNCTION SET SCREEN

Press **CH▲▼** or **SHUTTLE PLUS ▲▼** to move the highlight bar (arrow) to "FUNCTION SET", then press **OK** or **SHUTTLE PLUS ▷**.

MAIN MENU	
→	FUNCTION SET
	TUNER SET
	INITIAL SET
PRESS (▲, ▼), THEN (OK)	
PRESS (MENU) TO END	

4 SELECT VIDEO CALIBRATION MODE

Press **CH ▲▼** or **SHUTTLE PLUS ▲▼** to move the highlight bar (arrow) to "VIDEO CALIBRATION", then press **OK** or **SHUTTLE PLUS ▷** to set to "ON" or "OFF".

FUNCTION	
→	VIDEO CALIBRATION ON
	PICTURE CONTROL AUTO
	AUTO TIMER OFF
	SUPERIMPOSE ON
	AUTO SP→EP TIMER OFF
NEXT PAGE	
SELECT WITH (▲, ▼) AND (OK)	
PRESS (MENU) TO END	

NOTE:

When recording or when playing back tapes recorded on this VCR set the Video Calibration to "ON".

5 RETURN TO NORMAL SCREEN

Press **MENU**.

Recording

Perform steps 1 – 3 on page 23 ("Simple Recording") before continuing.

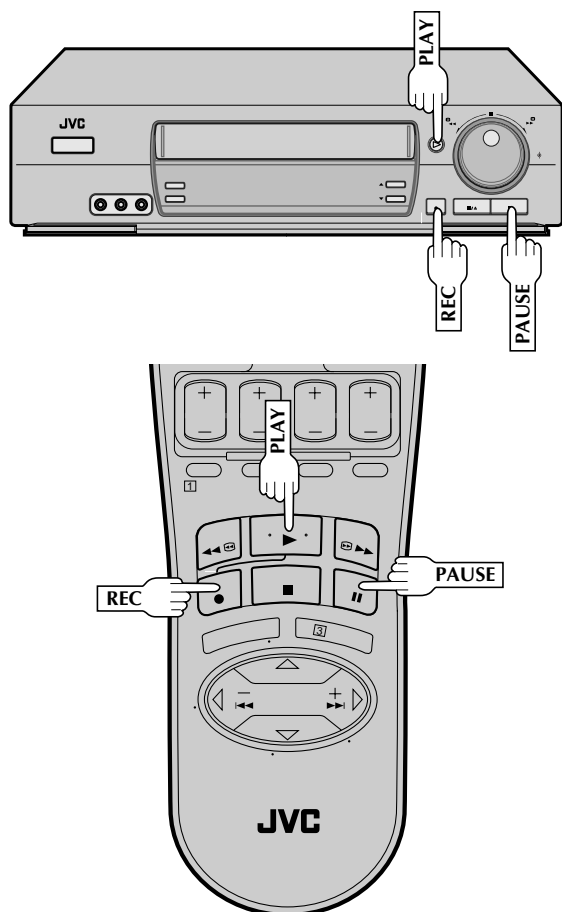

1

START RECORDING

Press and hold **REC** and press **PLAY** on the remote control, or press **REC** on the VCR's front panel.

- The VCR takes about 7 seconds to assess the quality of the tape in use, then recording begins with the picture level optimized.

DURING CALIBRATION

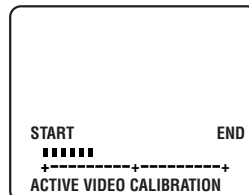

CALIBRATION COMPLETE

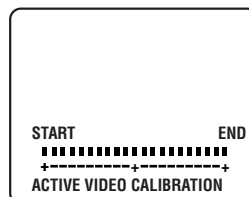

NOTES:

- Calibration occurs immediately prior to both the first SP and the first EP recording after inserting the cassette. It does not take place during recording.
- In the case of timer recording, calibration takes place for both SP and EP before the first timer recording after inserting the cassette (regardless of the tape speed selected for that recording).
- Once the cassette is ejected, the calibration data is canceled. The next time the cassette is used for recording, calibration is re-performed.
- While Video Calibration is operative, the **PAUSE** button will not function.
- To display the Video Calibration screen, "SUPERIMPOSE" must be set to "ON" or the Video Calibration screen will not appear (☞ pg. 29).

Playback

The VCR assesses the quality of the tape once you start playback.

Perform steps 1 and 2 on page 22 ("Simple Playback") before continuing.

1

START PLAYBACK

Press **PLAY**.

- The VCR adjusts the playback picture quality based on the quality of the tape in use.

—VIDEO CALIBRATION—

NOTES:

- When using rental tapes, or tapes recorded on other VCRs, set "VIDEO CALIBRATION" in step 4 of the Preparation procedure to either "ON" or "OFF" as desired to give the best picture (☞ pg. 32).
- The Video Calibration screen only appears at the beginning of automatic tracking. Even though the screen doesn't appear after that, the Video calibration function is operative.
- To display the Video Calibration screen, "SUPERIMPOSE" must be set to "ON" or the Video Calibration screen will not appear (☞ pg. 29).

ATTENTION:

- As calibration takes place before recording actually starts, there is a delay of about 7 seconds after **REC** and **PLAY** on the remote, or **REC** on the VCR's front panel, are pressed. To make sure you record the desired scene or program completely, first perform the following steps:
 - 1) Press and hold **PAUSE**, and press **REC** to engage the RECORD PAUSE mode.
 - The VCR then automatically checks the condition of the tape and, after about 7 seconds, re-enters RECORD PAUSE.
 - 2) Press **PLAY** to start recording.
 - If you want to bypass Video Calibration and start recording right away, set "VIDEO CALIBRATION" to "OFF" in step 4 of the Preparation procedure (☞ pg. 32).

Recording Features

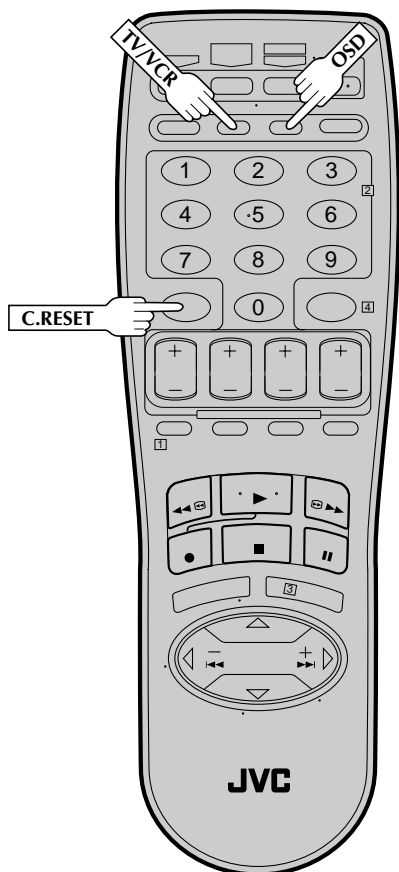

Record One Program While Watching Another

1 ENGAGE TV MODE

During recording...

- Press **TV/VCR**. The VCR's VCR indicator goes out. (If you are using the RF connection (☞ pg. 6) to view the output from your VCR, the TV broadcast being recorded disappears.)
- If you are using the AV connection (☞ pg. 6) to view the output from your VCR, change the TV's input mode from AV to TV.

2 SELECT CHANNEL FOR VIEWING

Use the TV's channel selector to set the channel you want to watch.

Display Elapsed Recording Time

1 RESET COUNTER TO ZERO

Before recording starts, press **C.RESET**. The counter resets to zero and displays the exact elapsed time as the tape runs.

2 DISPLAY ELAPSED TIME ON SCREEN

During recording, press **OSD** at any time to see the elapsed time.

All indications corresponding to the current status of the VCR are displayed for 5 seconds. The counter display remains on the screen indicating the elapsed time. Press **OSD** again to remove the display.

- Make sure "SUPERIMPOSE" is set to "ON" (☞ pg. 29).
- The indications are not recorded.

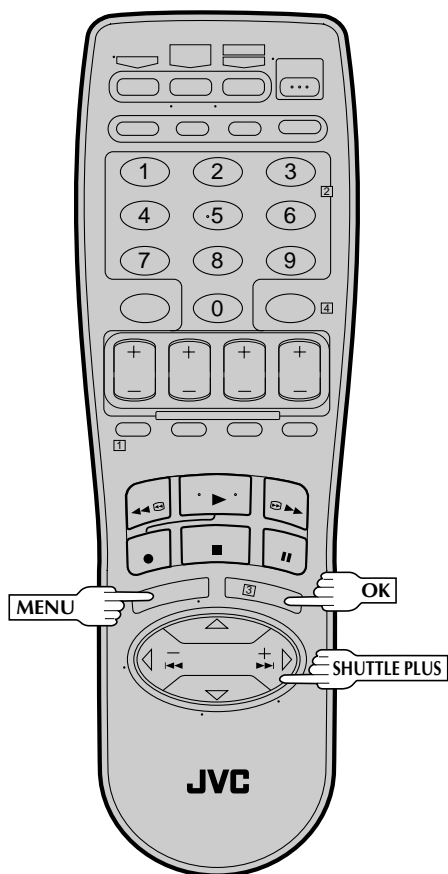
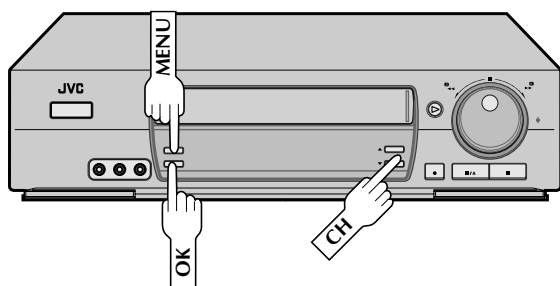

NOTES:

- If a SAP program is received and "2ND AUDIO RECORD" is set to "ON", the SAP audio is recorded on both the Normal and Hi-Fi tracks. The main audio program is not recorded.
- If a non-SAP program is received, the main audio is recorded on both the Hi-Fi and Normal audio tracks.

Stereo And SAP (Second Audio Program)

Your VCR's built-in MTS decoder enables reception of Multi-channel TV Sound broadcasts.

When the channel is changed...

- The "STEREO" indication appears on the screen for about 5 seconds if the program is a stereo broadcast.
- The "SAP" indication appears on the screen for about 5 seconds if the program is an SAP broadcast.
- Both indications appear when a stereo program is accompanied by SAP audio.

To Record Stereo Programs . . .

. . . simply follow the basic recording procedure.

To Listen To Stereo Soundtrack During Recording . . .

. . . set "AUDIO MONITOR" to "HI-FI" at the Function screen (pg. 27).

To Record SAP Programs . . .

ACCESS MAIN MENU SCREEN

Press **MENU**.

ACCESS FUNCTION SET SCREEN

Move the highlight bar (arrow) to "FUNCTION SET" by pressing **CH▲▼** or **SHUTTLE PLUS▲▼**, then press **OK** or **SHUTTLE PLUS▷**.

SELECT 2ND AUDIO RECORD SET MODE

Move the highlight bar (arrow) to "2ND AUDIO RECORD" by pressing **CH▲▼** or **SHUTTLE PLUS▲▼**, then press **OK** or **SHUTTLE PLUS▷** to set to "ON".

FUNCTION	
→VIDEO CALIBRATION	ON
PICTURE CONTROL	AUTO
AUTO TIMER	OFF
SUPERIMPOSE	ON
AUTO SP→EP TIMER	OFF
NEXT PAGE	
SELECT WITH (▲,▼) AND (OK)	
PRESS (MENU) TO END	



PREVIOUS PAGE	
VIDEO STABILIZER	ON
→2ND AUDIO RECORD	ON
AUDIO MONITOR	HI-FI
AV COMPU-LINK	ON
SELECT WITH (▲,▼) AND (OK)	
PRESS (MENU) TO END	

RETURN TO NORMAL SCREEN

Press **MENU**.

4

VCR Plus+ Timer Programming

Turn on the TV and select the VCR channel 3 or 4 (or AV mode).

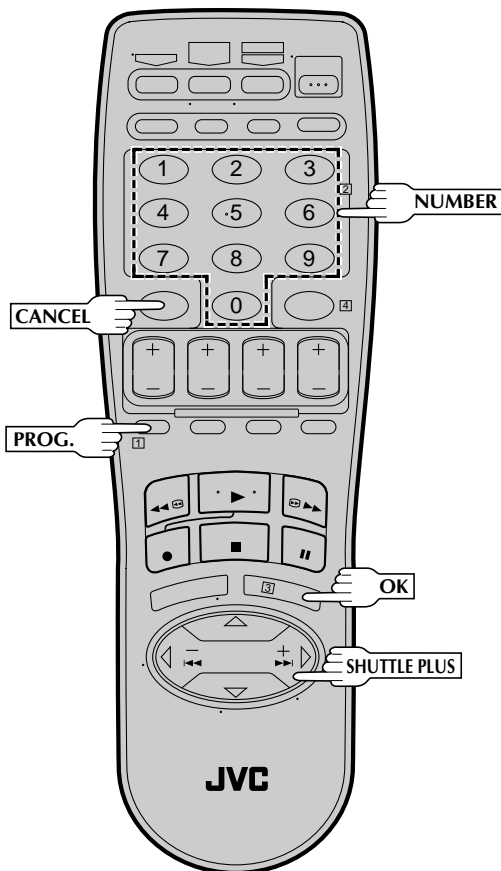
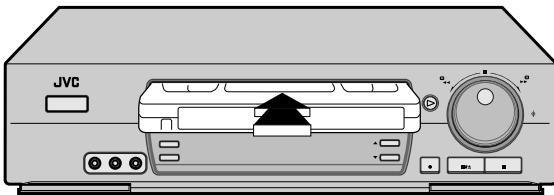

Timer recording allows you to program the VCR to automatically record a program that will be broadcast at some future time. The timer record function can be programmed using VCR Plus+ or Express Timer Programming up to 8 shows as far as a year in advance. (☞ pg. 36 or 40)

The VCR Plus+ timer programming system eliminates the need to input channel, date, start and stop time data when setting the timer record function. Simply key in the PlusCode number for the TV program you wish to record and the VCR's timer will be automatically programmed. (The PlusCodes are the numbers next to the programs in most TV listings.)

LOAD A CASSETTE

Make sure the record safety tab is present.

- The VCR's power comes on automatically.

ACCESS VCR PLUS+ SCREEN

Press **PROG.** on the remote control.

- The clock must be set in order to access the VCR Plus+ screen. If you haven't set the clock, the Main Menu screen appears after an error message is displayed.

Refer to page 8 for the Plug & Play procedure or page 11 for the clock setting procedure.

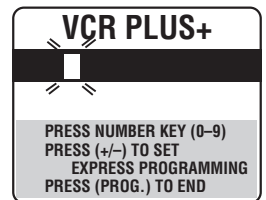

ENTER PLUSCODE NUMBER

Press the appropriate **NUMBER** keys to enter the PlusCode number printed in the TV listings for the TV program you wish to record and press **OK**.

If the Guide Channel Set screen appears, go to step 4. If the VCR Plus+ Program screen appears, go to step 5.

- To make corrections, press **CANCEL** and input the correct PlusCode number.

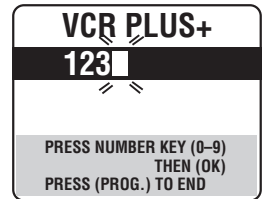

INPUT RECEIVING CHANNEL NUMBER

The Guide Channel Number, which is assigned to the TV or cable station for the PlusCode number that you entered in step 3, will appear automatically on the Guide Channel Set screen. Input the number of the channel on which the broadcast for the PlusCode number is received on the VCR or cable box using the **NUMBER** keys, **CH ▲▼** or **SHUTTLE PLUS** ▲▼, then press **OK**.

- The Guide Channel Set screen appears only when you input the PlusCode number of a station for which the Guide Channel number has not been set already.
- If you receive your channels with a cable box and if you have properly set your Controller, "CABLE CH" appears in place of "VCR CH". If not, refer to pages 16 - 18.

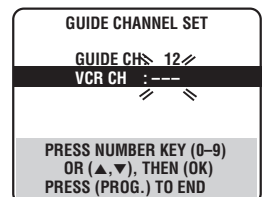

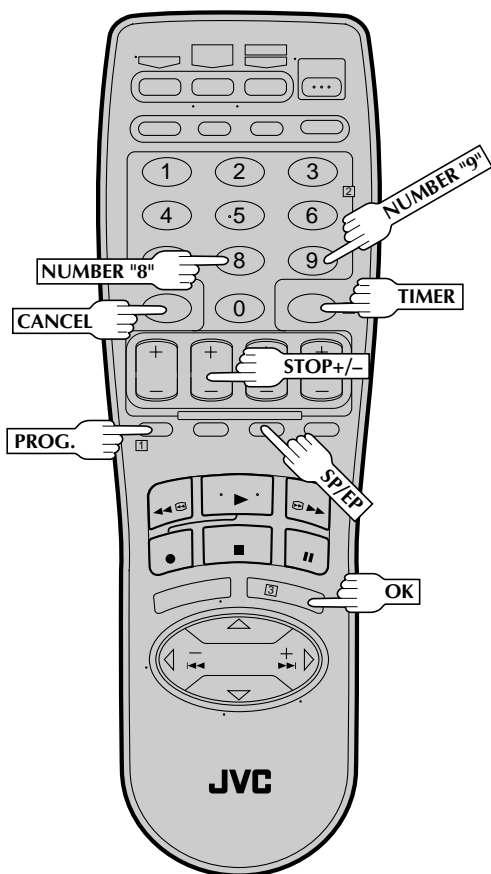

5 CHECK PROGRAM DATA

The PlusCode number you entered and the matching Timer-Recording information is displayed on the Program screen. Check to make sure it's accurate.

PROGRAM 1 (VCR PLUS+ 12345678)	
START	STOP
8:00PM	→ 10:00PM
DATE	CH
12/24/98	12 SP
THU	
PRESS (8=DAILY, 9=WEEKLY STOP +/- = STOP TIME, SP/EP) PRESS (OK) TO END	

- To change the stop time, press **STOP +/-**.
- To timer-record daily or weekly serials, press **DAILY** (NUMBER "8") or **WEEKLY** (NUMBER "9"). "DAILY" or "WEEKLY" appears on the Program screen. Pressing the button again makes each corresponding display disappear.
- If you made a mistake, press **CANCEL** to access the VCR Plus+ screen again and input the correct PlusCode number.
- If the PlusCode number you inputted is incorrect, "ERROR" may appear on the screen to advise you of the error. This happens when the PlusCode number is for a program which has already passed. "ERROR" is displayed for about 5 seconds and the VCR Plus+ screen reappears.

6 SET TAPE SPEED

Press **SP/EP**.

7 RETURN TO NORMAL SCREEN

Press **PROG.** or **OK**. "PROGRAM COMPLETED" appears on the screen for about 5 seconds, then normal screen appears.

8 ENGAGE TIMER MODE

Press **TIMER**. The VCR turns off automatically and "⊕" is displayed on the display panel.

ATTENTION

If there is a conflict in the timer schedule and one program overlaps with another, only the parts shown below in gray will be recorded.

Pattern 1: The program with the lower program number will be recorded.

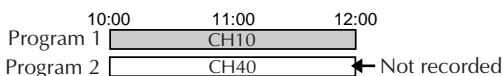

Pattern 2: The program that is broadcast earlier will be recorded.

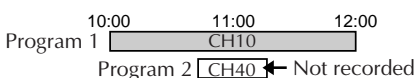

Pattern 3: The program that is broadcast earlier will be recorded, followed by the remaining portion of the other program.

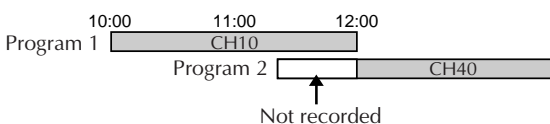

IMPORTANT

If you have moved to a different area or if a broadcasting station's channel number has been changed, the wrong VCR or CABLE CH number will be displayed on the VCR Plus+ Program screen in step 5. When this happens, set the correct Guide Channel number for that station. (☞ pg. 38, "VCR Plus+ Setup")

NOTES:

- To disengage the timer before recording starts, press **TIMER** again. Pressing once more re-engages it.
- In case of a power failure after programming, the VCR's memory backup keeps your selections for approximately 10 minutes.
- When timer-recording cable channels received through a Cable Box, be sure to keep the Cable Box set to ON.

VCR Plus+ Setup

Turn on the TV and select the VCR channel 3 or 4 (or AV mode).

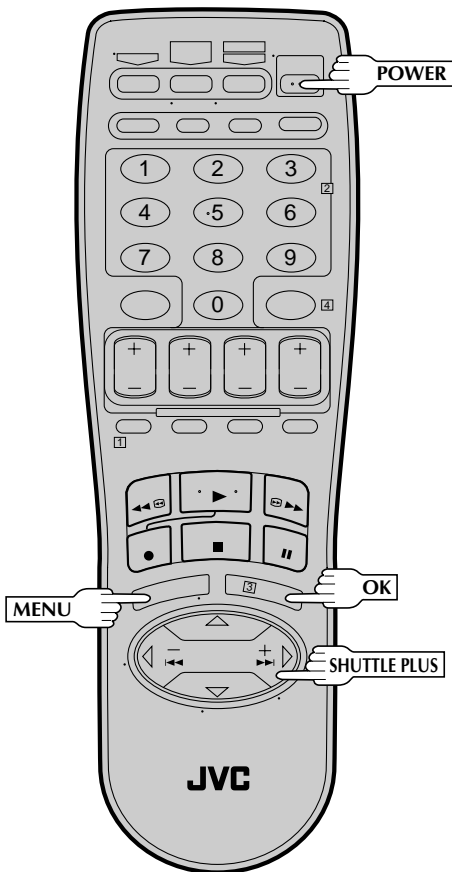
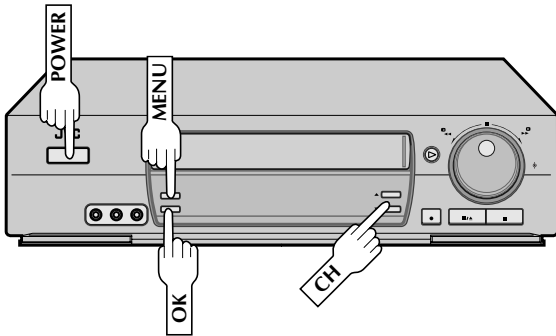

IMPORTANT

If you have moved to a different area or if a broadcasting station's channel number has been changed, the wrong VCR or CABLE CH number will be displayed on the VCR Plus+ Program screen (☞ step 5 on page 37). When this happens, perform the following steps to set the correct Guide Channel number for that station.

To ensure that VCR Plus+Timer Recording operates correctly it is necessary to set the VCR Plus+ "Guide Channel Set" for each station. Please read the following information carefully.

VCR Plus+ Guide Channel Matching

VCR Plus+ assigns a VCR Plus+ "Guide Channel" to broadcast and cable TV channels. These Guide Channel numbers are also called the VCR Plus+ Channel Codes. Most TV listings have a section, usually a chart, indicating the "Guide Channel" numbers assigned to each station. For accurate VCR Plus+ Programming the VCR Plus+ Guide Channel number for each station should match the channel number on which it is received in your area.

NOTES:

- In many instances the VCR Plus+ Guide Channel numbers for cable and broadcast TV stations **DO NOT** match the channel number on which it is received by your VCR or cable box. Check your TV listing, or contact your cable supplier for details.
- Many broadcast TV stations can be viewed on cable. Check your TV listing, or contact your cable supplier for details.

TURN ON THE VCR

Press **POWER**.

ACCESS MAIN MENU SCREEN

Press **MENU**.

ACCESS INITIAL SET SCREEN

Press **CH▲▼** or **SHUTTLE PLUS△▽** to move the highlight bar (arrow) to "INITIAL SET", then press **OK** or **SHUTTLE PLUS▷**.

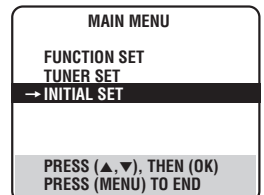

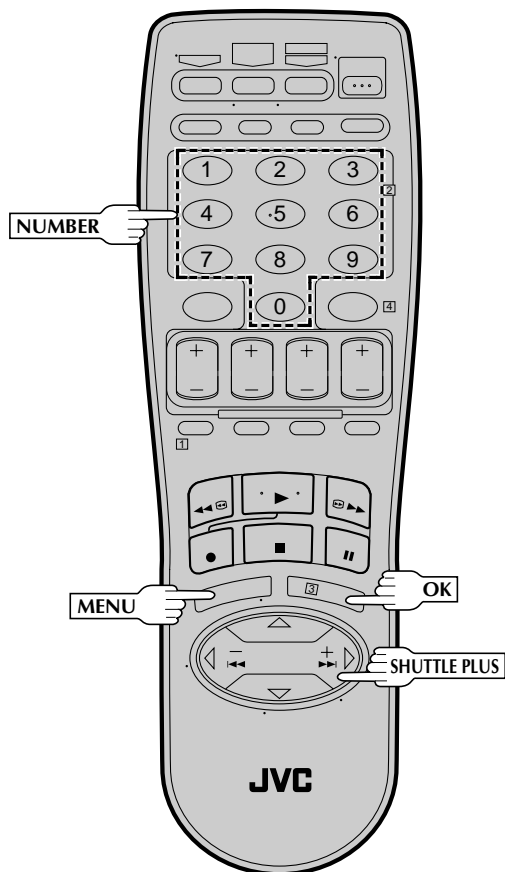
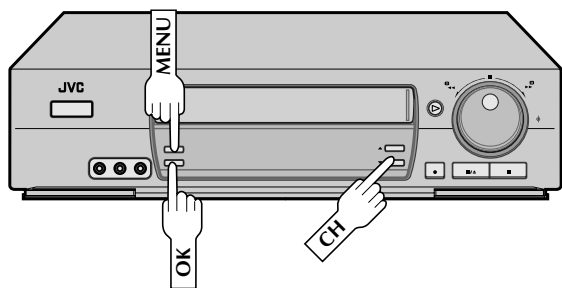

4

ACCESS GUIDE CHANNEL SET SCREEN

Press **CH▲▼** or **SHUTTLE PLUS▲▽** to move the highlight bar (arrow) to "GUIDE CHANNEL SET", then press **OK** or **SHUTTLE PLUS▷**.

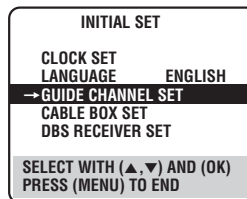

5

Press **CH▲▼**, **SHUTTLE PLUS▲▽** or the appropriate **NUMBER** keys to input the VCR Plus+ Guide Channel number as shown in the TV listing. Then press **OK** or **SHUTTLE PLUS▷**.

(Ex.) When inputting the Guide Channel number 6 for WNJU(Ind.)

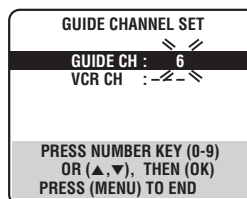

- If you receive your channels with a cable box and if you have properly set your Controller, "CABLE CH" appears in place of "VCR CH". If not, refer to pages 16 – 18 and re-perform the procedure.

6

INPUT RECEIVING CHANNEL NUMBER

Press **CH▲▼**, **SHUTTLE PLUS▲▽** or the appropriate **NUMBER** keys to input the number of the channel on which the Guide Channel's broadcasts are received. Then press **OK** or **SHUTTLE PLUS▷**.

(Ex.) If WNJU(Ind.) is received on channel 47

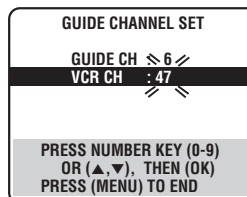

- Repeat steps 5 and 6 for each instance.

RETURN TO NORMAL SCREEN

7

Press **MENU**.

Express Timer Programming

Turn on the TV and select the VCR channel 3 or 4 (or AV mode).

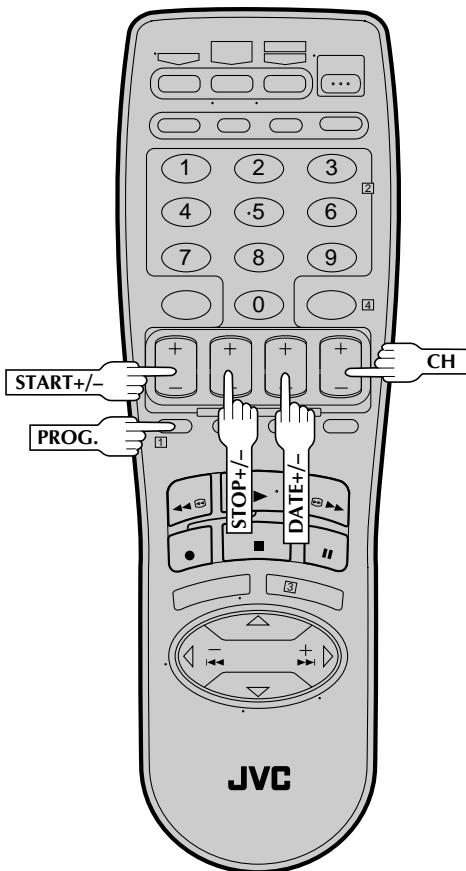
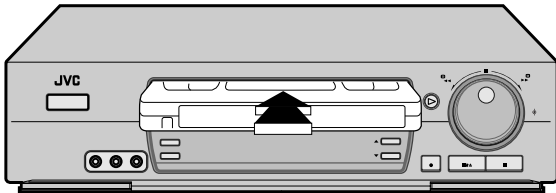

You can directly program the VCR's timer to record up to 8 shows, as far as a year in advance. Remember, the clock must be set before you can program the timer (pg. 8 or 11).

1

LOAD A CASSETTE

Make sure the record safety tab is intact. If not, cover the hole with adhesive tape, then load it into the VCR.

- The VCR comes on, and the counter is reset, automatically.

2

ACCESS VCR PLUS+ SCREEN

Press **PROG.**

3

ACCESS PROGRAM SCREEN

Press **START +/-**. (If you're just starting out, "PROGRAM 1" appears.)

PROGRAM 1	
START	STOP
--:--AM → --:--AM	
DATE	CH
--/--	---
PRESS (+/-, SP/EP, 8=DAILY, 9=WEEKLY), THEN (OK)	
PRESS (PROG.) TO END	

4

SET PROGRAM START TIME

Press **START +/-** to enter the time you want recording to start.

- Press and hold **START +/-** to move in 30-minute increments, or press and release repeatedly to move 1 minute at a time.

PROGRAM 1	
START	STOP
8:00 AM → --:--AM	
DATE	CH
--/--	---
PRESS (+/-, SP/EP, 8=DAILY, 9=WEEKLY), THEN (OK)	
PRESS (PROG.) TO END	

5

SET PROGRAM STOP TIME

Press **STOP +/-** to enter the time you want recording to stop.

- Press and hold **STOP +/-** to move in 30-minute increments, or press and release repeatedly to move 1 minute at a time.

6

SET PROGRAM DATE

Press **DATE +/-**. (The current date is displayed on screen. The date you enter appears in its place.)

7

SET CHANNEL NUMBER

Press **CH +/-**.

- If you are using a DBS receiver, see "ATTENTION FOR DBS RECEIVER USERS" on next page.
- Holding down **CH +/-** rapidly scans through the channels.

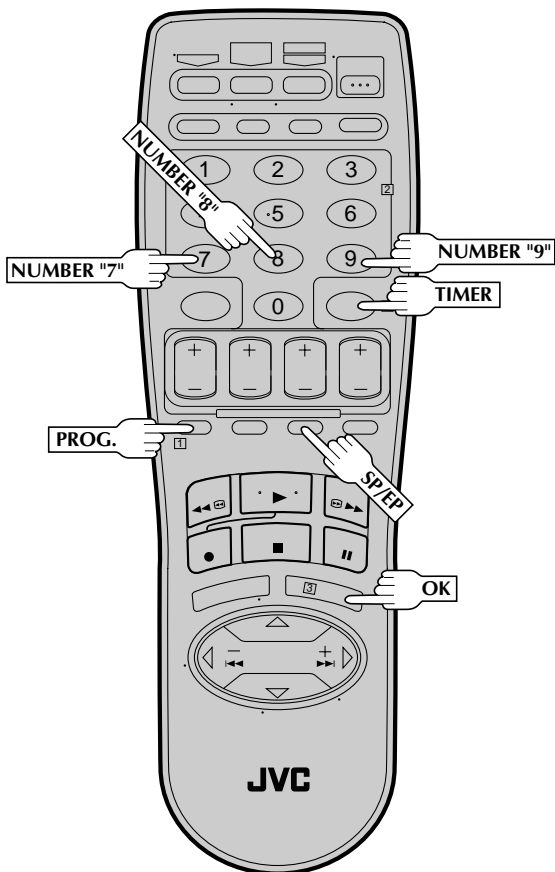

8 SET TAPE SPEED

Press **SP/EP** to set the tape speed.

9 RETURN TO NORMAL SCREEN

Press **PROG.** or **OK**. "PROGRAM COMPLETED" appears on the screen for about 5 seconds, then normal screen appears.

10 ENGAGE TIMER MODE

Press **TIMER**. The VCR turns off automatically and "⊕" is displayed on the display panel.

To Timer-Record Weekly Or Daily Serials . . .
 . . . anytime during steps 3 through 9, press **WEEKLY** (NUMBER key "9") for weekly serials or **DAILY** (NUMBER key "8") for daily serials (Monday–Friday). Either "WEEKLY" or "DAILY" appears on the screen. Pressing the button again makes the corresponding indication disappear.

NOTES:

- To disengage the timer before recording starts, press **TIMER** again. Pressing once more re-engages it.
- In case of a power failure after programming, the VCR's memory backup keeps your selections for approximately 10 minutes.
- Programs that start after midnight must have the next day's date.
- After timer recording is completed, the VCR's power goes off automatically.
- You can program the timer while a regular recording is in progress; the on-screen menu will not be recorded.
- If the end of tape is reached during timer recording, the cassette is automatically ejected.
- When timer-recording cable or satellite channels through an external tuner, be sure to keep the cable box or satellite receiver's power ON.

ATTENTION FOR DBS RECEIVER USERS

If you are using a DBS receiver (unless "DBS RECEIVER SET" is set to "OFF" ☞ pg. 20), the BAND indication (TV or CATV or DBS) appears under the channel number display. If the channel number that has been entered requires that the band be set, "7=DBS" is displayed on the screen. Press the **NUMBER** key "7" to select the desired band.

PROGRAM 1	
START	STOP
8:00AM →	9:00PM
DATE	CH
12/24/98	110 SP
THU	DBS
PRESS (+/-, SP/EP, 8=DAILY, 9=WEEKLY, 7=DBS), THEN (OK) PRESS (PROG.) TO END	

- a– TV : To timer-record a regular TV program received on the VCR.
- b– CATV : To timer-record a cable TV program received on the VCR, or through a cable box (unless "CABLE BOX SET" is set to "OFF" ☞ pg. 17).
- c– DBS : To timer-record a satellite program received through a DBS receiver.
- If "BAND" is set to "TV" at the Tuner Set screen (☞ pg. 14) and "CABLE BOX SET" is set to "OFF" at the Cable Box Set screen (☞ pg. 17), CATV will not be displayed on the Program screen; If "BAND" is set to "CATV" or "CABLE BOX SET" is set to "ON", TV will not be displayed.

ATTENTION

If there is a conflict in the timer schedule and one program overlaps with another, only the parts shown below in gray will be recorded.

Pattern 1: The program with the lower program number will be recorded.

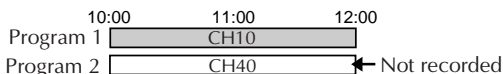

Pattern 2: The program that is broadcast earlier will be recorded.

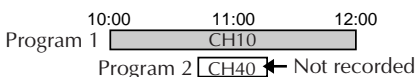

Pattern 3: The program that is broadcast earlier will be recorded, followed by the remaining portion of the other program.

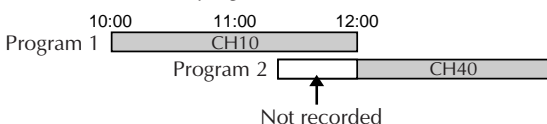

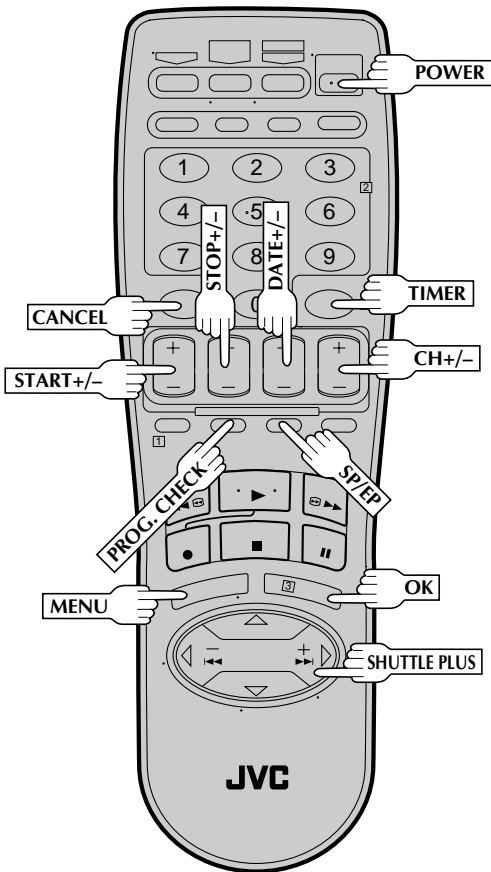
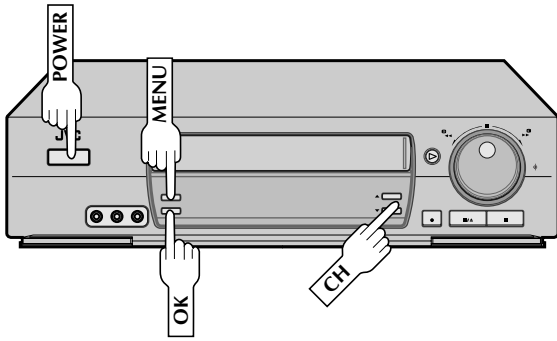

Check, Cancel And Revise Programs

1 DISENGAGE TIMER

Press **TIMER**, then press **POWER**.

2 ACCESS PROGRAM CHECK SCREEN

Press **PROG. CHECK**.

PR	START	STOP	CH	DATE
1	8:00P	10:00	12	12/24
2	10:00A	10:45	40	12/25
3	11:30P	1:00	125	12/25
4				
5				
6				
7				
8				

PRESS (CHECK) TO NEXT

3 ACCESS PROGRAM SCREEN

Press **PROG. CHECK** again to check more information. Each time you press **PROG. CHECK**, the next program's information appears.

To Cancel Or Revise A Program...

4 CANCEL OR REVISE A PROGRAM

To cancel a program, press **CANCEL**.
To revise a program, press the appropriate button: **START+/-**, **STOP+/-**, **DATE+/-**, **CH+/-**, **SP/EP**.

5 RETURN TO NORMAL SCREEN

Press **PROG. CHECK** as many times as necessary. If there are still programs remaining, go to step 6.

6 RE-ENGAGE TIMER

Press **TIMER**.

Auto SP→EP Timer

If, when recording in SP mode, there is not enough tape to record the entire program, the VCR automatically switches to EP mode to allow complete recording. This feature is especially handy when recording a program of more than 2 hours in length.

For Example . . .

Recording a program of 140 minutes in length onto a 120-minute tape

Approximately 110 minutes Approximately 30 minutes

SP mode	EP mode
---------	---------

Total 140 minutes

Make sure you set "AUTO SP→EP TIMER" to "ON" at the Function screen before the timer recording starts.

1 ACCESS MAIN MENU SCREEN

Press **MENU**.

2 ACCESS FUNCTION SET SCREEN

Move the highlight bar (arrow) to "FUNCTION SET" by pressing **CH ▲▼** or **SHUTTLE PLUS ▲▽**, then press **OK** or **SHUTTLE PLUS ▷**.

3 SELECT AUTO SP→EP TIMER SET MODE

Move the highlight bar (arrow) to "AUTO SP→EP TIMER" by pressing **CH ▲▼** or **SHUTTLE PLUS ▲▽**, then press **OK** or **SHUTTLE PLUS ▷** to set to "ON".

FUNCTION	
VIDEO CALIBRATION	ON
PICTURE CONTROL	AUTO
AUTO TIMER	OFF
SUPERIMPOSE	ON
→ AUTO SP→EP TIMER	ON
NEXT PAGE	
SELECT WITH (▲,▽) AND (OK)	
PRESS (MENU) TO END	

4 RETURN TO NORMAL SCREEN

Press **MENU**.

Auto Timer

When the Auto Timer is set to ON the timer is automatically engaged when the VCR's power is turned off. It is automatically disengaged when the VCR is powered back on.

1 ACCESS MAIN MENU SCREEN

Press **MENU**.

2 ACCESS FUNCTION SET SCREEN

Move the highlight bar (arrow) to "FUNCTION SET" by pressing **CH ▲▼** or **SHUTTLE PLUS ▲▽**, then press **OK** or **SHUTTLE PLUS ▷**.

3 SELECT AUTO TIMER SET MODE

Move the highlight bar (arrow) to "AUTO TIMER" by pressing **CH ▲▼** or **SHUTTLE PLUS ▲▽**, then press **OK** or **SHUTTLE PLUS ▷** to set to "ON" or "OFF".

FUNCTION	
VIDEO CALIBRATION	ON
PICTURE CONTROL	AUTO
→ AUTO TIMER	OFF
SUPERIMPOSE	ON
AUTO SP→EP TIMER	ON
NEXT PAGE	
SELECT WITH (▲,▽) AND (OK)	
PRESS (MENU) TO END	

4 RETURN TO NORMAL SCREEN

Press **MENU**.

NOTE:

For safety, when AUTO TIMER is set to "OFF", all other VCR functions are disabled while the Timer mode is engaged. To disengage the timer, press **TIMER**.

NOTES:

- If you have programmed the VCR to timer-record 2 or more programs, the second program and those thereafter may not fit on the tape though you set the Auto SP→EP Timer mode to "ON". In this case, make sure the mode is not engaged, then set the tape speed manually during timer programming.
- In order to ensure that the recording fits on the tape, this feature may leave a slight non-recorded section at the end of the tape.
- There may be some noise at the point on the tape where the VCR switches from SP to EP mode.
- The Auto SP→EP Timer feature is not available during ITR (Instant Timer Recording), and the feature will work with the following tapes: T(ST)-30, T(ST)-60, T(ST)-90, and T(ST)-120.

Instant Timer Recording (ITR)

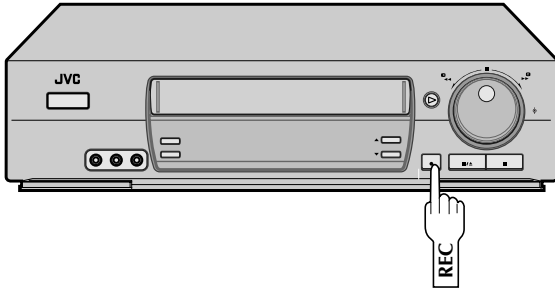

This easy method lets you record from 30 minutes to 6 hours (selectable in 30-min. increments) and shuts the VCR off after recording is finished.

1 START RECORDING

Press **REC** on the front panel.

2 ENGAGE ITR MODE

Press **REC** again. "  " blinks and 0:30 appears on the front display panel.

3 SET RECORDING DURATION

If you want to record for more than 30 minutes, press **REC** to extend the time. Each press extends recording time by 30 minutes.

NOTES:

- You can only perform ITR using the **REC** button on the VCR's front panel.
- After you set the ITR time, the previous display reappears.
- To check the remaining time, press **REC** once during recording and the remaining time will be displayed for about 5 seconds. Be careful not to press **REC** again within these 5 seconds, or you will round the recording time up to the next 30 minute increment.

Edit To Or From Another VCR

You can use your VCR as the player or the recorder.

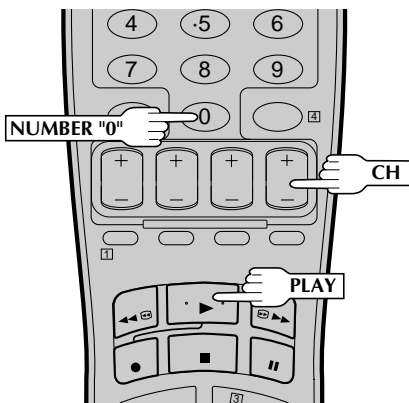
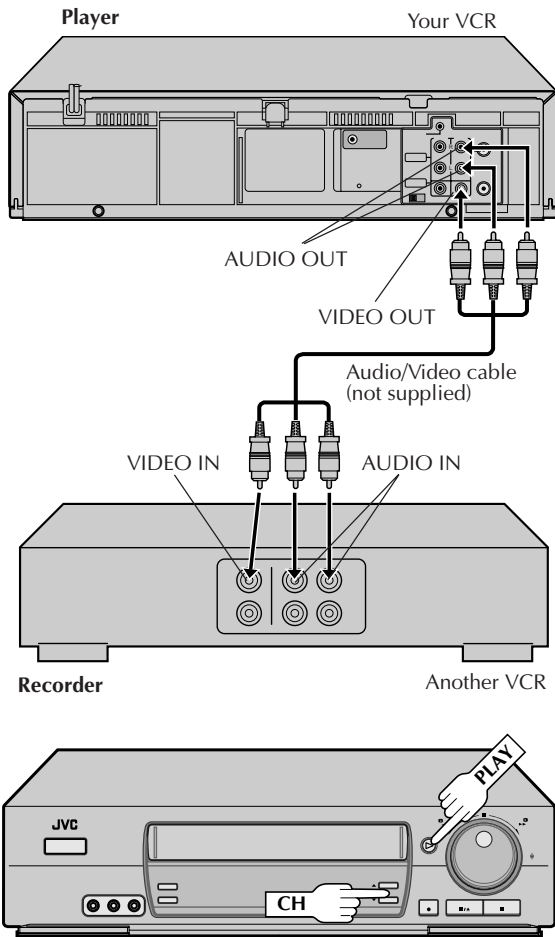

1 MAKE CONNECTIONS

Connect an AV cable between the player's VIDEO OUT and AUDIO OUT connectors and the recorder's VIDEO IN and AUDIO IN connectors.

- When using your VCR as the recorder and a monaural VCR as the player, connect the player's AUDIO OUT connector to the AUDIO IN L connector on the recorder.

2 LOAD CASSETTES

Insert the playback cassette into the player and the cassette to be recorded on into the recorder.

3 SET RECORDER'S INPUT MODE

Set to "AUX". With this VCR, press the **NUMBER** key "0" and/or **CH** to select depending on the connector being used - "L-1" for the rear AUDIO/VIDEO IN connectors, or "F-1" for the front AUDIO/VIDEO IN connectors.

4 SELECT "EDIT" FOR PICTURE CONTROL SET MODE

Follow the "Picture Control" section on page 26, then select "EDIT."

NOTE:

When you select "EDIT" to dub tapes, be sure to select **AUTO** or (**NORM** when **VIDEO CALIBRATION** is set to **OFF**) after you finish dubbing the tapes.

5 START PLAYER

Set to its play mode.

NOTE:

If the player is equipped with a superimpose/OSD disable feature then set "SUPERIMPOSE" to **OFF** before pressing **PLAY** (see pg. 29).

6 START RECORDER

Set to its record mode.

Edit From A Camcorder

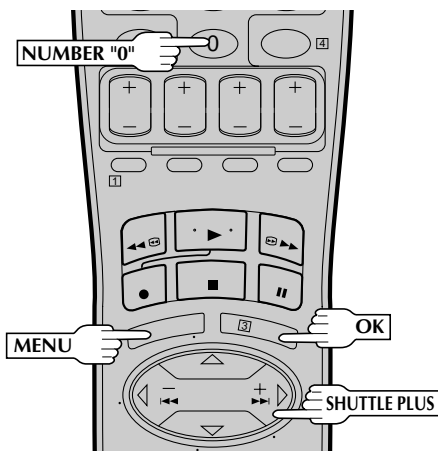
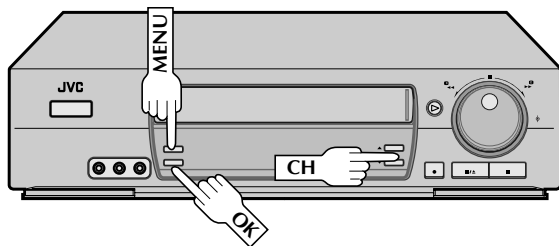
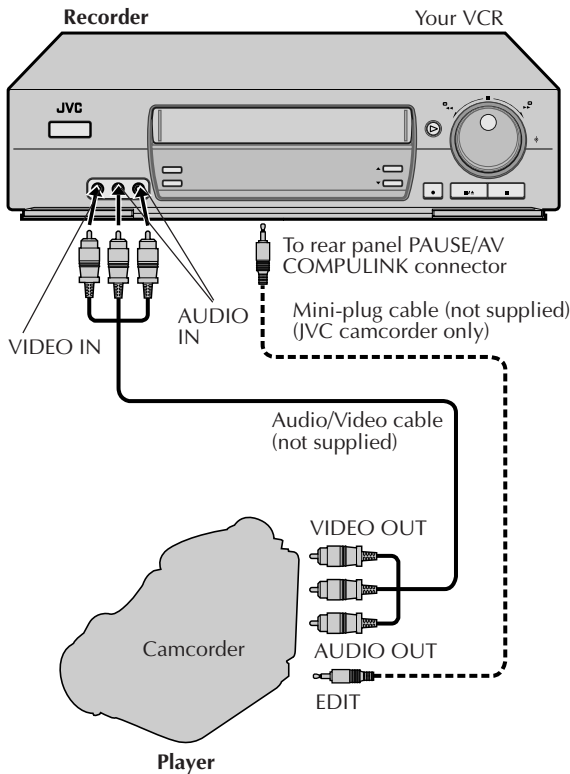

You can use a camcorder as the player and your VCR as the recorder.

1 MAKE CONNECTIONS

Connect an AV cable between the camcorder's VIDEO OUT and AUDIO OUT connectors and your VCR's VIDEO IN and AUDIO IN connectors.

- When a Master Edit Control-equipped JVC camcorder is used, the camcorder is capable of controlling your VCR. The mini-plug cable is a mono 3.5 mm mini-plug to mono 3.5 mm mini-plug connector.
- If connecting to a camcorder with a monaural output, connect the audio output connector on the camcorder to AUDIO IN L of the VCR.

2 LOAD A CASSETTE

Insert the cassette to be recorded on into the recorder.

3 SELECT "EDIT" FOR PICTURE CONTROL SET MODE

Follow the "Picture Control" section on page 26, then select "EDIT."

NOTE:

When you select "EDIT" to dub tapes, be sure to select AUTO or (NORM when VIDEO CALIBRATION is set to OFF) after you finish dubbing the tapes.

4 SET RECORDER'S INPUT MODE

Set to "AUX". Press the NUMBER key "0" and/or CH to select depending on the connector being used - "L-1" for the rear AUDIO/VIDEO IN connectors, or "F-1" for the front AUDIO/VIDEO IN connectors.

If you're using a JVC Master Edit Control-equipped camcorder — step 5
If not — step 8

5 ACCESS MAIN MENU SCREEN

Press MENU.

6 ACCESS FUNCTION SET SCREEN

Press CH ▲▼ or SHUTTLE PLUS ▲▼ to move the highlight bar (arrow) to "FUNCTION SET", then press OK or SHUTTLE PLUS ▷.

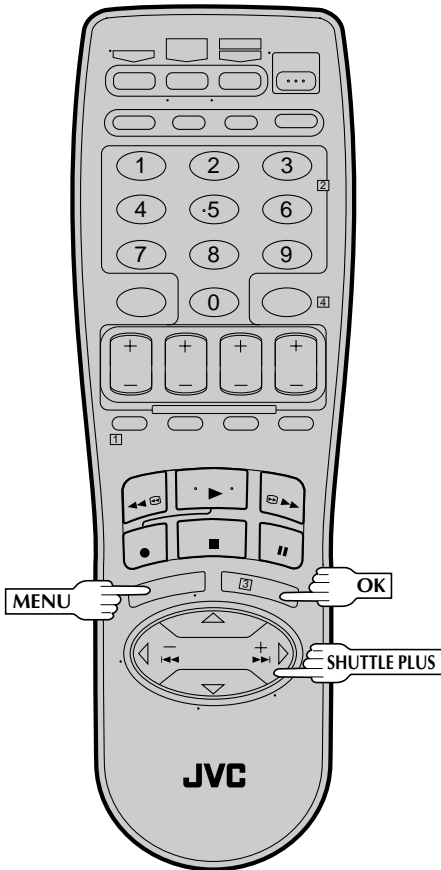
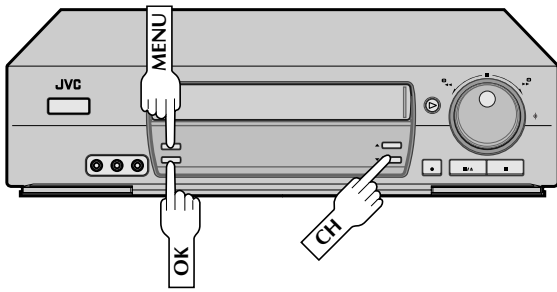

7

ENABLE REMOTE PAUSE FUNCTION

Press **CH ▲▼** or **SHUTTLE PLUS ▲▼** to move the highlight bar (arrow) to "AV COMPU-LINK", then press **OK** or **SHUTTLE PLUS ▸** to set to "OFF".

- The PAUSE/AV COMPU-LINK connector works as the AV CompuLink Playback connector when "AV COMPU-LINK" is set to "ON" (pg. 31), and works as the Remote Pause connector when "AV COMPU-LINK" is set to "OFF".

FUNCTION	
→ VIDEO CALIBRATION	ON
PICTURE CONTROL	AUTO
AUTO TIMER	OFF
SUPERIMPOSE	ON
AUTO SP→EP TIMER	OFF
NEXT PAGE	
SELECT WITH (▲, ▼) AND (OK)	
PRESS (MENU) TO END	



PREVIOUS PAGE	
VIDEO STABILIZER	ON
2ND AUDIO RECORD	ON
AUDIO MONITOR	HI-FI
→ AV COMPU-LINK	OFF
SELECT WITH (▲, ▼) AND (OK)	
PRESS (MENU) TO END	

8

RETURN TO NORMAL SCREEN

Press **MENU**.

9

START PLAYER

Set the camcorder to its play mode.

NOTE:

If the camcorder is equipped with a superimpose/OSD disable feature then set its superimpose or display feature to OFF before pressing play.

10

START RECORDER

Set your VCR to its record mode.

- If you are using a Master Edit Control-equipped JVC camcorder, it can put the recorder automatically into Record mode. (Refer to camcorder's instruction manual.)

TV Multi-Brand Remote Control

The VCR's remote control can control several functions on JVC remote control TVs and on the brands of remote control TVs listed below. *The default setting is JVC code 01.

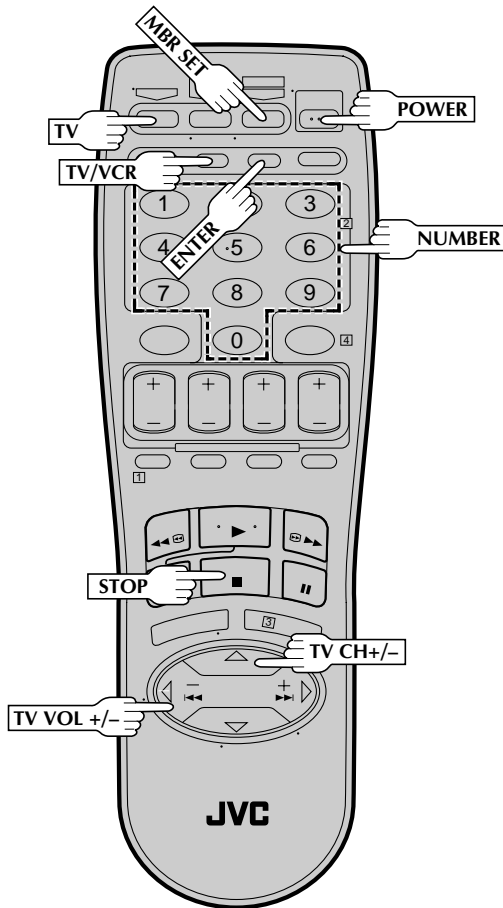

1 TURN ON THE TV

Turn the power on using the TV's remote control.

2 SET TV BRAND CODE

Refer to the chart in the left column. While holding down **TV** on the VCR's remote control, press **MBR SET** and enter your TV's brand code using the **NUMBER** keys, then press **STOP**.

Follow the example shown below.

Check if the TV's power goes off as it should. If it does, try other operations (☞ step 3).

- Once you have set the remote control to operate the TV, you don't have to repeat this step until you replace your remote control's batteries.
- PANASONIC has two codes. If the TV does not function with one code, try entering the other.

3 OPERATE TV

First, while holding down **TV**, press the corresponding button: **POWER**, **TV CH +/-**, **TV/VCR**, **TV VOL +/-**, **NUMBER** keys.

- For some brands of TV, you must press **ENTER** after having pressed the **NUMBER** keys.

NOTE:

Depending on the type of TV, there may be cases where some or all functions cannot be operated using the remote control.

TV BRAND NAME	BRAND CODE
JVC	01
MAGNAVOX	02
MITSUBISHI	03
PANASONIC	04, 11
RCA	05
SHARP	06
SONY	07
TOSHIBA	08
ZENITH	09
HITACHI	10
SAMSUNG	12
SANYO	13
SEARS	13

(Ex.) To set remote control to RCA 05:

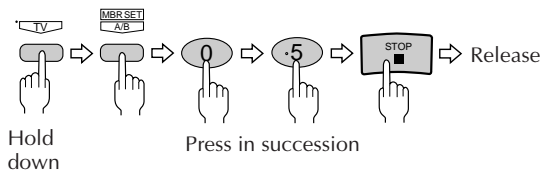

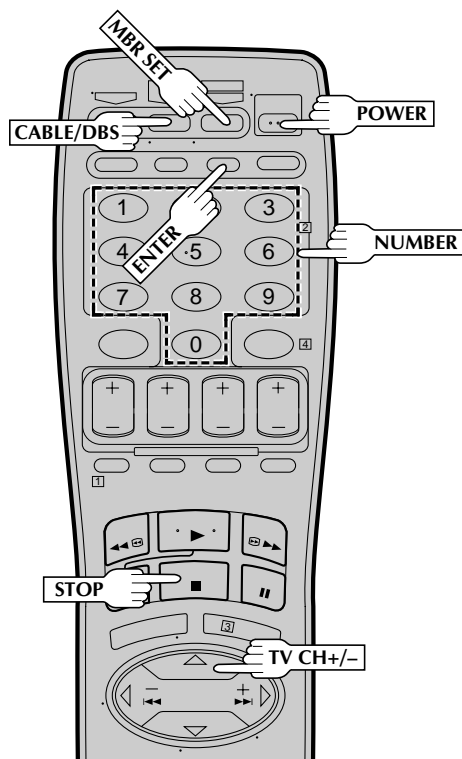

Cable Box Multi-Brand Remote Control

The VCR's remote control can control functions on the brands of cable boxes listed below. Some cable box brands have more than one code. If your cable box does not function with a specified code, try other codes.

1 TURN ON THE CABLE BOX

Turn the power on using the cable box's remote control.

2 ENTER CABLE BOX BRAND

While holding down **CABLE/DBS** on the VCR's remote control, press **MBR SET** and use the **NUMBER** keys to enter the cable box brand number from the chart in the left column and then press **STOP**.

Follow the example shown below.

Check if the cable box's power goes off as it should. If it does, try other operations (☞ step 3).

- Once you have set the remote control to operate the cable box, you don't have to repeat this step until you replace the remote control's batteries.

3 OPERATE CABLE BOX

First, while holding down **CABLE/DBS**, press the corresponding button: **POWER**, **TV CH +/-**, **NUMBER** keys.

- For some brands of cable box, you must press **ENTER** after having pressed the **NUMBER** keys.
- To change the cable box's channel, press **TV CH +/-** or the **NUMBER** keys. (The **CH +/-** button can be used to change the VCR's channel only.)

NOTES:

- Depending on the type of cable box, there may be cases where some or all functions cannot be operated using the remote control.
- It's not possible to set the remote control for both your cable box and a DBS receiver at the same time. You can only set the remote control to operate one of these units at a time.

(Ex.) To set remote control to RCA 14:

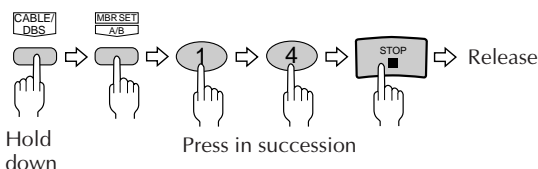

CABLE BOX BRAND NAME	BRAND CODE
ARCHER	01, 05, 17
CABLETENNA	01, 17
CABLEVIEW	15, 16, 17, 21, 25
CITIZEN	15, 16, 17, 21, 25
CURTIS	02
DIAMOND	01, 17
EASTERN	19
GC BRAND	15, 16, 17, 21, 25
GEMINI	15
GENERAL INSTRUMENTS	01, 04, 06, 11, 12, 15
HAMLIN	10, 18, 19, 23
JASCO	15
JERROLD	01, 04, 06, 11, 12, 15
NOVAVISION	02
OAK	07
PANASONIC	13, 14
PULSER	15, 16, 17, 21, 25
RCA	13, 14
REGAL	10, 18, 19, 23
REGENCY	19
REMBRANDT	01, 16, 17
SAMSUNG	05, 16, 24
SCIENTIFIC ATLANTA	02
SIGMA	07
SL MARX	05, 16, 17, 24, 25
SPRUCER	13, 14
STARGATE	05, 15, 16, 17, 21, 24, 25
TELEVIEW	05, 16, 24
TOCOM	01, 04, 16
UNIKA	01, 17
UNIVERSAL	16, 17, 25
VIDEOWAY	03, 09, 22
ZENITH	03, 09, 22

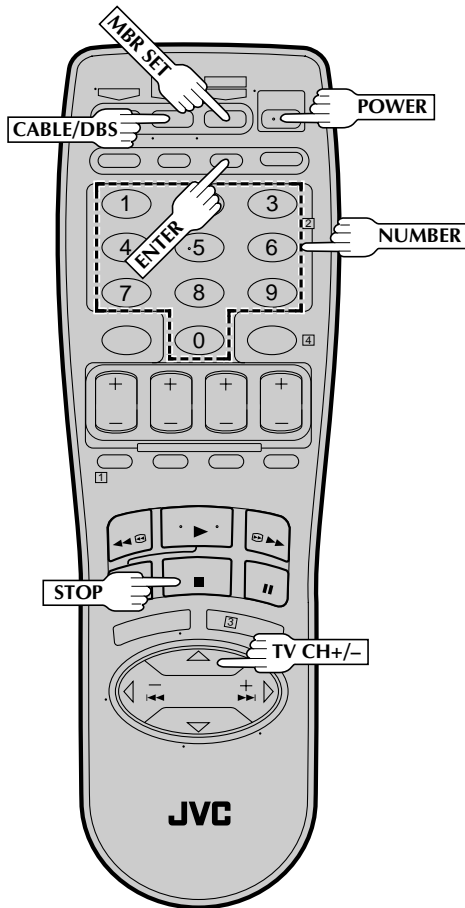

DBS Receiver Multi-Brand Remote Control

The VCR's remote control can control functions on the brands of DBS (Direct Broadcast Satellite) receivers listed below.

1 TURN ON THE DBS RECEIVER

Turn the power on using the DBS receiver's remote control.

2 ENTER DBS RECEIVER BRAND

While holding down **CABLE/DBS** on the VCR's remote control, press **MBR SET** and use the **NUMBER** keys to enter the DBS receiver brand number from the chart in the left column and then press **STOP**.

Follow the example shown below.

Check if the DBS receiver's power goes off as it should. If it does, try other operations (➡ step 3).

- Once you have set the remote control to operate the DBS receiver, you don't have to repeat this step until you replace the remote control's batteries.

3 OPERATE DBS RECEIVER

First, while holding down **CABLE/DBS**, press the corresponding button: **POWER**, **TV CH +/-**, **NUMBER** keys.

- Depending on the DBS receiver you may have to press **ENTER** after having pressed the **NUMBER** keys.
- To change the DBS receiver's channel, press **TV CH +/-** or the **NUMBER** keys. (The **CH +/-** button can be used to change the VCR's channel only.)

NOTES:

- Depending on the type of DBS receiver, there may be cases where some or all functions cannot be operated using the remote control.
- It's not possible to operate a DBS receiver that is not equipped with a remote control sensor.
- Though ECHOSTAR has a number of different remote codes, this remote control is applicable only to one of those codes preset at the factory.
- It's not possible to set the remote control for both your DBS receiver and a cable box at the same time. You can only set the remote control to operate one of these units at a time.

DBS BRAND NAME	BRAND CODE
JVC (DISH Network)	51
ECHOSTAR (DISH Network)	51
PRIMESTAR	50
SONY (DSS)	41
RCA (DSS)	40

(Ex.) To set remote control to JVC 51:

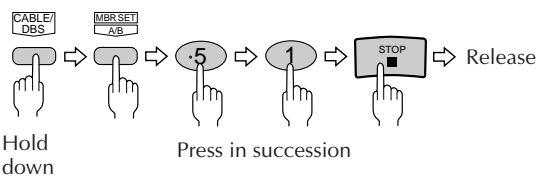

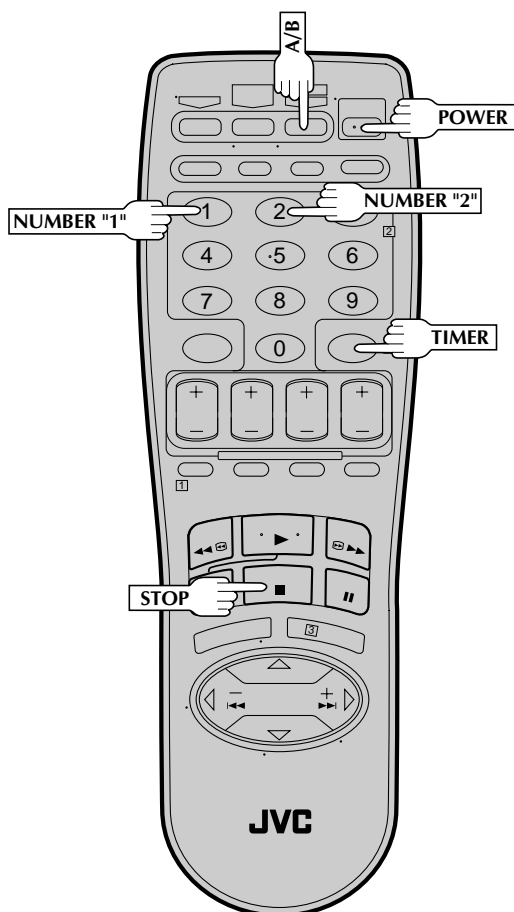

Control Two JVC VCRs

The remote control is capable of controlling two JVC VCRs independently; one set to respond to your remote control's **A** code control signals and another set to respond to **B** code control signals. The remote control is preset to send **A** code signals because your VCR is initially set to respond to **A** code signals. You can easily modify your VCR to respond to **B** code signals.

1 UNPLUG VCR'S POWER CORD

Unplug from the AC outlet.

2 SET REMOTE CONTROL CODE

While holding down **A/B** on the remote control, press the **NUMBER** key "2" and then press **STOP**.

3 PLUG IN POWER CORD

Plug back in to the AC outlet.

4 TURN VCR POWER ON

Press **POWER** on the remote.

The VCR will now respond only to B-code commands. To set the VCR back to respond to A code signals, repeat the same procedure as shown above except pressing **NUMBER** key "1" instead of "2" in step 2.

You can control two VCRs with the same remote control by switching the remote's code between A and B (⇐ Step 2).

Child Lock

This feature allows you to prevent the operation of the VCR.

1 TURN VCR POWER ON

Press **POWER**.

2 ENGAGE CHILD LOCK

Press and hold **POWER** on the remote control until the Child Lock indicator ("—") appears on the front display panel.

- Power turns OFF and the VCR cannot be turned on from the **POWER** button on the front panel.
- To cancel Child Lock, press and hold **POWER** on the remote until the VCR turns on. During timer recording, pressing **TIMER** also cancels Child Lock.

NOTES:

- When Child Lock is engaged, make sure to keep the remote control out of the reach of children.
- Timer recording of programs that were previously set can be performed while the Child Lock is engaged. The feature remains in effect after the recording is finished.



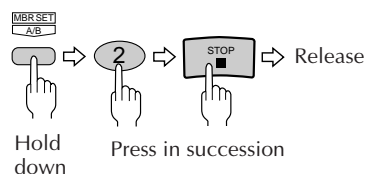













(Ex.) To set remote control B code:



Before requesting service for a problem, use this chart and see if you can repair the trouble yourself. Small problems are often easily corrected, and this can save you the trouble of sending your VCR off for repair.

POWER		
SYMPTOM	POSSIBLE CAUSE	CORRECTIVE ACTION
1. The power won't come on.	<ul style="list-style-type: none"> • The power cord is disconnected. 	Connect the power cord.
2. The clock works, but the VCR's power won't come on.	<ul style="list-style-type: none"> • The TIMER mode is engaged with Auto Timer set to "OFF" (☞ pg. 43). • The Child Lock mode is engaged. 	Press TIMER to disengage. Press and hold POWER on the remote to disengage the mode (☞ pg. 51).
3. The remote control won't function.	<ul style="list-style-type: none"> • The batteries are discharged. 	Replace the dead batteries with new ones.
TAPE TRANSPORT		
SYMPTOM	POSSIBLE CAUSE	CORRECTIVE ACTION
1. The cassette gets stuck partway during loading, and is ejected.	<ul style="list-style-type: none"> • The cassette was inserted incorrectly. 	Make sure the cassette's window is facing up, the rear label side is facing you and the arrow on the front of the cassette is pointing towards the VCR. Then insert the cassette.
PLAYBACK		
SYMPTOM	POSSIBLE CAUSE	CORRECTIVE ACTION
1. The tape is running but the picture won't appear.	<ul style="list-style-type: none"> • If you're using the RF OUT connection (☞ pg. 6), the channel selector on the TV is set incorrectly. • If you're using the AV connection (☞ pg. 6), the TV receiver is set to the wrong mode. 	Set the channel selector to channel 3 or 4. Set the TV receiver to its AV mode.
2. Noise appears during visual search.	<ul style="list-style-type: none"> • This is normal. 	
3. Breaks are noticeable in Hi-Fi soundtrack.	<ul style="list-style-type: none"> • Automatic tracking is engaged. 	Disengage Auto Tracking and adjust the tracking manually (☞ pg. 25).
4. The playback picture is blurred or interrupted, even though TV broadcasts are clear.	<ul style="list-style-type: none"> • The video heads may be dirty. 	The heads must be cleaned. Consult your JVC dealer.
5. The Hi-Fi soundtrack cannot be heard.	<ul style="list-style-type: none"> • The AUDIO MONITOR option was set incorrectly. 	Set AUDIO MONITOR to "HI-FI" (☞ pg. 27).
RECORDING		
SYMPTOM	POSSIBLE CAUSE	CORRECTIVE ACTION
1. Recording won't start.	<ul style="list-style-type: none"> • There's no cassette loaded. • The loaded cassette has had its record safety tab removed. 	Insert a cassette. Remove the cassette and cover the hole with adhesive tape, or load a cassette on which the record safety tab is intact.
2. TV broadcasts won't record properly.	<ul style="list-style-type: none"> • The VCR has been set to its AUX mode by mistake. 	Set the VCR to the appropriate channel.
3. Tape-to-tape editing won't work.	<ul style="list-style-type: none"> • The VCRs or the camcorder and the VCR have been incorrectly connected. • The power to one or more of the units has not been turned on. • The recorder's input mode has been set incorrectly. 	Refer to the directions and the illustration under "Edit To Or From Another VCR" (☞ pg. 45) or "Edit From A Camcorder" (☞ pg. 46) and properly connect the units. Make sure the power to all units is on. Select the recorder's appropriate input mode.

TIMER RECORDING

SYMPTOM	POSSIBLE CAUSE	CORRECTIVE ACTION
1. Timer recording won't work.	<ul style="list-style-type: none"> ● The clock and/or the timer have been set incorrectly. ● The timer is not engaged. ● The VCR has not been set up properly. 	<p>Set the clock and/or timer correctly.</p> <p>Press TIMER and check to make sure that  appears on the front display panel.</p> <p>Re-perform the set-up procedures. Make sure you have compensated for Guide Channel and VCR or cable box channel number mismatches ( pg. 38).</p>
2. Timer programming won't work.	<ul style="list-style-type: none"> ● Timer recording is in progress. 	<p>Timer programming can't be performed when timer recording is in progress. Wait until it finishes.</p>
3.  and  on the front display panel won't stop blinking.	<ul style="list-style-type: none"> ● The timer is engaged but there's no cassette loaded. 	<p>Load a cassette with the record safety tab intact, or with the hole covered with adhesive tape.</p>
4. The cassette is automatically ejected, and  and  on the front display panel won't stop blinking.	<ul style="list-style-type: none"> ● The loaded cassette has had its record safety tab removed. 	<p>Remove the cassette and cover its hole with adhesive tape, or replace it with a cassette on which the safety tab is intact.</p>
5.  blinks for 10 seconds and the timer mode is disengaged.	<ul style="list-style-type: none"> ● TIMER has been pressed when there are no programs in memory, or the timer record program information has not been programmed correctly. 	<p>Check the programmed data and re-program as necessary, then press TIMER again.</p>
6. The cassette is automatically ejected, the power shuts off and  and  won't stop blinking.	<ul style="list-style-type: none"> ● The end of tape was reached during timer recording. 	<p>The program may not have been recorded in its entirety. Next time make sure you have enough time on the tape to record the entire program.</p>
7. Cable channels are not automatically switched during timer recording.	<ul style="list-style-type: none"> ● The Controller is not properly connected to the VCR. ● The output channel selected in the Cable Box Set screen is incorrect. ● The cable box's power is off. 	<p>Connect the Controller correctly ( pg. 16).</p> <p>After confirming your cable box's output channel number, re-access the Cable Box Set screen and select the correct number ( pg. 17).</p> <p>Make sure the power is on before timer recording starts.</p>
8. Satellite channels are not automatically switched during timer recording.	<ul style="list-style-type: none"> ● The Controller is not properly connected to the VCR. ● The output channel selected in the DBS Receiver Set screen is incorrect. ● The VCR is not set correctly to control the DBS Receiver ● The DBS receiver's power is off. 	<p>Connect the Controller correctly ( pg. 19).</p> <p>After confirming your DBS receiver's output channel number, re-access the DBS Receiver Set screen and select the correct number ( pg. 20).</p> <p>Set the correct DBS Receiver brand code ( pg. 21).</p> <p>Make sure the power is on before timer recording starts.</p>
9. Timer recording begins as scheduled, but the channel is always incorrect.	<ul style="list-style-type: none"> ● Even though you don't use an external Cable Box, "CABLE BOX SET" is set to "ON". 	<p>Set "CABLE BOX SET" to "OFF" ( pg. 17).</p>
10. We moved, and now VCR Plus+ doesn't work properly.	<ul style="list-style-type: none"> ● The receivable stations in the new area are received on different channels than those in the previous area. 	<p>Re-perform the VCR Plus+ setup procedure ( pg. 38).</p>
11. "PROGRAM FULL" is displayed on the screen.	<ul style="list-style-type: none"> ● All 8 programs of the VCR's timer memory are used. 	<p>Wait until a space in memory clears, or cancel unnecessary program information ( pg. 42).</p>

CONTINUED ON NEXT PAGE.

OTHER PROBLEMS

SYMPTOM	POSSIBLE CAUSE	CORRECTIVE ACTION
1. When scanning channels, some of them are skipped over.	<ul style="list-style-type: none"> Those channels have been preset to be skipped. 	If you need the skipped channels, restore them (☞ pg. 15).
2. The channel can't be changed.	<ul style="list-style-type: none"> Recording is in progress. 	Press PAUSE to pause the recording, change channels, then press PLAY to resume recording.
3. The remote control won't operate my TV or cable box or DBS receiver.	<ul style="list-style-type: none"> The remote control brand setting is incorrect. 	Re-set the remote control to the correct brand (☞ pg. 48 or 49 or 50).
4. Even though Auto or Semi-Auto clock setting has been selected, the clock is incorrect.	<ul style="list-style-type: none"> The clock setting data received from the Host Channel is incorrect. 	Select a different Host Channel during the Semi-Auto setting procedure (☞ pg. 12), or perform the Manual setting procedure (☞ pg. 13).

ATTENTION:

This VCR contains microcomputers. External electronic noise or interference can cause microcomputer to malfunction. If the VCR does not operate correctly switch its power off and unplug the power cord from the AC supply. Wait for a while and then plug the power back in. Eject and check the condition of the cassette. If everything appears normal resume operating the VCR as usual.

PLAYBACK

- Q. What happens if the end of the tape is reached during playback or search?**
A. The tape is automatically rewound to the beginning.
- Q. Can the VCR indefinitely remain in the still mode?**
A. No. It stops automatically after 5 minutes to protect the heads.
- Q. During search, slow, still and frame-by-frame playback, I can't hear any audio. What's the problem?**
A. This is normal.
- Q. During search, still and frame-by-frame playback, the picture is intermittent. What's the cause?**
A. Picture loss occurs when these types of playback are attempted with a tape recorded in LP mode. Pressing **PLAY** to return to normal playback will restore the picture.
- Q. When returning from multi-speed search to normal playback, the picture is disturbed. Should I be concerned about this?**
A. No, it is normal.
- Q. Noise bars appear during multi-speed search. What's the problem?**
A. This is normal.
- Q. When playing back programs that have been timer-recorded with consecutive times (such one program from 8:00 to 9:00 and another one from 9:00 to 10:00), the picture and sound become momentarily distorted at the point where the first program ends and the second program begins. Is this a malfunction?**
A. No. This is normal.
- Q. Other than preventing further recording, what effect does removing the safety tab have?**
A. It disables marking of index codes.
- Q. Sometimes, during Index Search, the VCR can't find the program I want to see. Why not?**
A. There may be index codes too close together.
- Q. During playback, on-screen operational indicators sometimes jitter. Why does this happen?**
A. If the condition of the tape being played back is not good, jittering of the video (including on-screen indicators) may occur.

RECORDING

- Q. When I pause and then resume a recording, the end of the recording before the pause is overlapped by the new recording. Why does this happen?**
A. This is normal. It reduces distortion at the pause and resume points.
- Q. Can the VCR indefinitely remain in the Record-Pause mode?**
A. No. The VCR automatically goes to its Stop mode after 5 minutes to protect the heads. When paused during Instant Timer Recording (ITR), the VCR shuts off automatically after 5 minutes.
- Q. What happens if the tape runs out during recording?**
A. The VCR automatically rewinds it to the beginning.

TIMER RECORDING

- Q. REC and ⊖ remain lit on the front display panel. Is there a problem?**
A. No. This is a normal condition for a timer recording in progress.
- Q. Can I program the timer while I'm watching a tape or a TV broadcast?**
A. Yes, but while you are setting the timer you won't see the tape's or broadcast program's picture as it is replaced by the on-screen menu. The audio from the tape or broadcast program will be present during the setting of the timer.

List Of Terms

This guide serves as a quick way to locate frequently used terms and on-screen display names.

A

A/B Code	51
Active Video Calibration	32
Add Channel	15
Audio Monitor	27
Auto Channel Setting	14
Auto Daylight Saving Time	12
Auto SP→EP Timer	43
Auto Timer	43
Automatic Tracking	25
Aux Input	45
AV Compu Link Playback	31
AV Connection	6

B

Band	14
------------	----

C

Cable Box	16
Cable Box Brand Setting	18
Cable Box Controller	16
Cancel Program	42
Cassette Adapter	22
Check Program	42
Child Lock	51
Connection to TV	6
Contents	5
Counter Reset	28

D

DBS Receiver	19
DBS Receiver Brand Setting	21
DBS Receiver Controller	19
Delete Channel	15

E

Editing	45
Express Timer Programming	40
Express Timer Recording	40

F

Frame-by-Frame Playback	24
-------------------------------	----

G

Guide Channel Setting	39
-----------------------------	----

H

Host Channel Selection	12
------------------------------	----

I

Index Search	25
Insert Cassette	22
Instant ReView	25
ITR (Instant Timer Recording)	44

L

Language Selection	10
--------------------------	----

M

Main Menu	10
Manual Channel Setting	15
Manual Clock Setting	13
Manual Tracking	25
MBR (Multi-Brand Remote) Code Setting	48
Movie Advance	30

N

Next-Function Memory	28
----------------------------	----

O

On-Screen Display	29
-------------------------	----

P

PBS Channel	8
Picture Control	26
Playback	22
Plug & Play	8

R

Record Safety Tab	23
Recording	23
Repeat Playback	28
Reverse Motion Playback	24
Reverse Slow Motion Playback	24
RF Connection	6

S

SAP (Second Audio Program)	35
Second Audio	35
Select Cable Box Output Channel	17
Select DBS Receiver Output Channel	20
Semi-Auto Clock Setting	12
Skip Search	25
Slow Motion Playback	24
Specifications	60
SQPB (S-VHS Quasi Play Back)	22
Still Picture Playback	24
Superimpose	29

T

Tape Position Indicator	28
Tape Speed Setting	23
Time Zone Selection	13
Tuner Setting	14

V

Variable-Speed Search	24
VCR Plus+ Timer Programming	36
VCR Plus+ Timer Recording	36
Video Stabilizer	27

FRONT VIEW

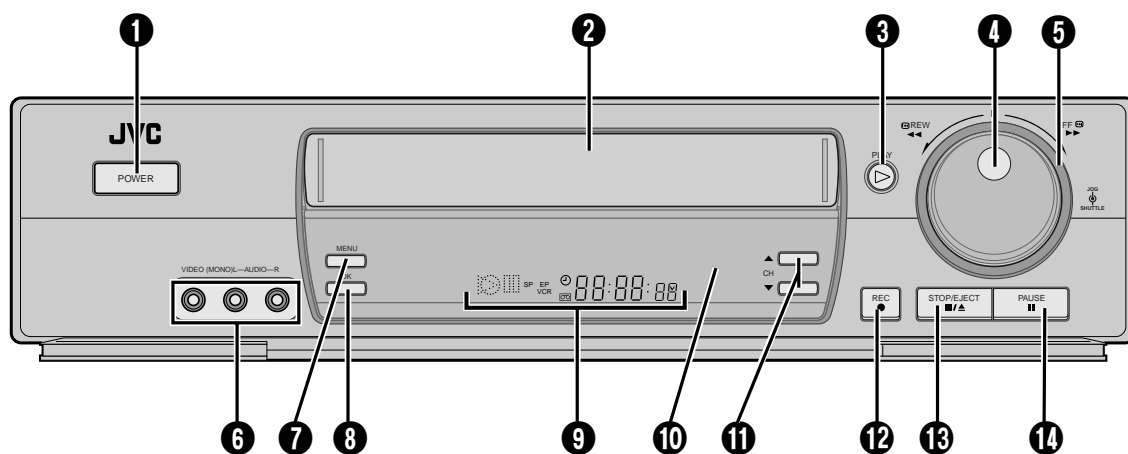

- ❶ Power On/Off Button (☞ pg. 10)
- ❷ Cassette Loading Slot
- ❸ PLAY Button (☞ pg. 22)
- ❹ JOG dial (☞ pg. 24)
- ❺ SHUTTLE ring (☞ pg. 22)
- ❻ VIDEO/AUDIO Input Connectors (☞ pg. 46)
- ❼ MENU Button (☞ pg. 10)
- ❽ OK Button (☞ pg. 10)
- ❾ Front Display Panel (☞ pg. 58)
- ❿ Remote Control Sensor
- ⓫ Channel [CH] ▲▼ Button (☞ pg. 23)
- ⓬ Record [REC] Button (☞ pg. 23)
- ⓭ STOP/EJECT Button (☞ pg. 22)
- ⓮ PAUSE Button (☞ pg. 24)

REAR VIEW

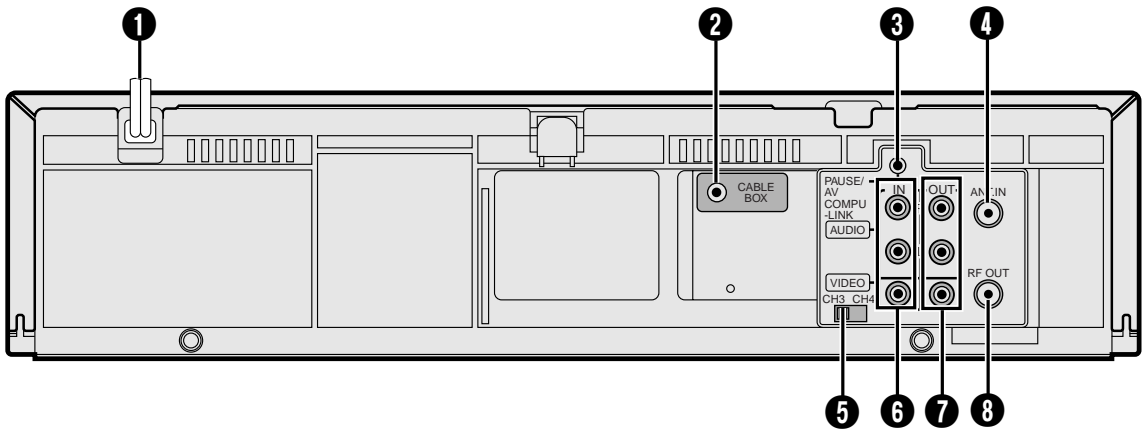

- ❶ Power Cord (☞ pg. 6)
- ❷ CABLE BOX Controller Connector (☞ pg. 16, 19)
- ❸ PAUSE/AV COMPULINK Connector
 - Remote PAUSE Connector (☞ pg. 46)
 - AV COMPULINK Connector (☞ pg. 31)
- ❹ ANT. IN Connector (☞ pg. 6)
- ❺ Channel 3/4 Switch (☞ pg. 6)
- ❻ VIDEO/AUDIO Input Connectors (☞ pg. 45)
- ❼ VIDEO/AUDIO Output Connectors (☞ pg. 45)
- ❽ RF OUT Connector (☞ pg. 6)

FRONT DISPLAY PANEL

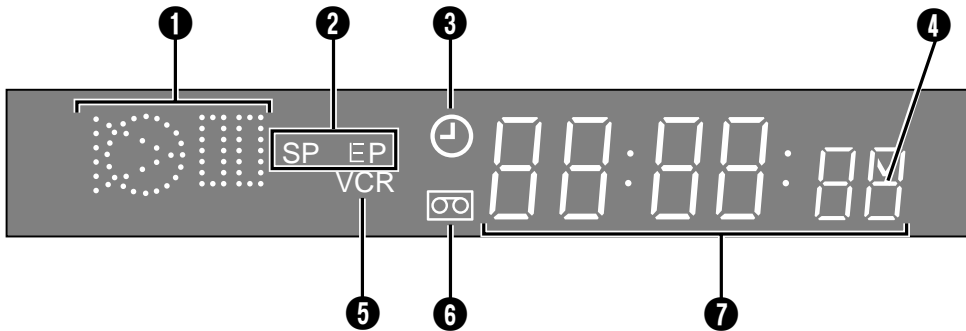

❶ Symbolic Mode Indicators

PLAY: FF/REW VARIABLE SEARCH:		STILL: SLOW:	
		RECORD:	
		RECORD PAUSE:	

- ❷ Tape Speed Indicators (☞ pg. 23)
- ❸ Timer Mode Indicator (☞ pg. 37, 41)
- ❹ Child Lock (-) Indicator (☞ pg. 51)
- ❺ VCR Mode Indicator (☞ pg. 34)
- ❻ "Cassette Loaded" Mark
- ❼ Channel Display ["L-1" and "F-1" for AUX mode]
Counter Display (☞ pg. 8)
Clock Display (☞ pg. 8)

REMOTE CONTROL

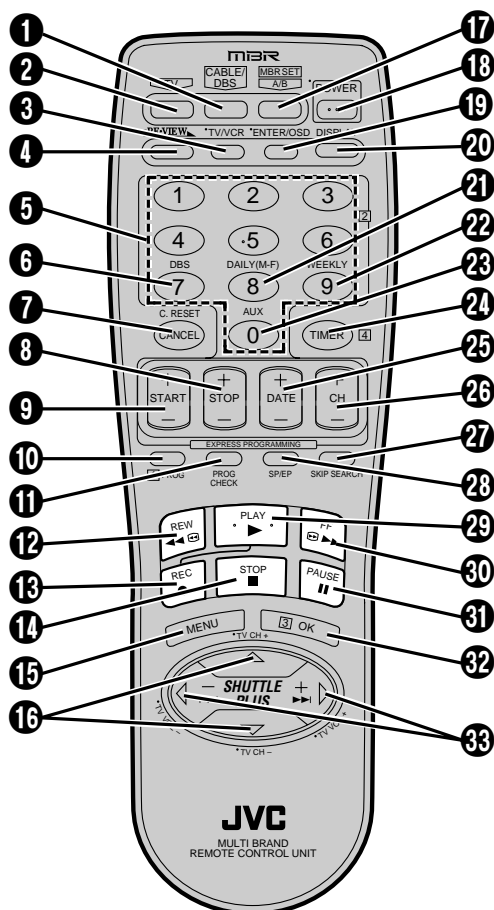

- 1 CABLE/DBS Button (☞ pg. 49, 50)
- 2 TV Button (☞ pg. 48)
- 3 TV/VCR Button (☞ pg. 34)
- 4 Instant REVIEW Button (☞ pg. 25)
- 5 NUMBER Buttons (☞ pg. 23, 36)
- 6 DBS Button (☞ pg. 41)
- 7 CANCEL Button (☞ pg. 42)
- 8 Counter [C.] RESET Button (☞ pg. 28)
- 9 STOP +/- Button (☞ pg. 40)
- 10 START +/- Button (☞ pg. 40)
- 11 PROG. Button (☞ pg. 36, 40)
- 12 PROG. CHECK Button (☞ pg. 42)
- 13 Rewind [REW] Button (☞ pg. 22)
- 14 Record [REC] Button (☞ pg. 23)
- 15 STOP Button (☞ pg. 22)
- 16 MENU Button (☞ pg. 10)
- 17 SHUTTLE PLUS $\Delta \nabla$ Button (☞ pg. 10)
- 18 TV Channel [CH] +/- Button (☞ pg. 48, 49, 50)
- 19 MBR SET Button (☞ pg. 48, 49, 50)
- 20 A/B Code Button (☞ pg. 51)
- 21 POWER On/Off Button (☞ pg. 10)
- 22 ENTER Button (☞ pg. 23)
- 23 On-Screen Display [OSD] Button (☞ pg. 29)
- 24 DISPLAY Button (☞ pg. 28)
- 25 DAILY Timer Recording Button (☞ pg. 37, 41)
- 26 WEEKLY Timer Recording Button (☞ pg. 37, 41)
- 27 "AUX" Mode Select Button (☞ pg. 45)
- 28 TIMER Button (☞ pg. 37, 41)
- 29 DATE +/- Button (☞ pg. 40)
- 30 Channel [CH] +/- Button (☞ pg. 23, 40)
- 31 SKIP SEARCH Button (☞ pg. 25, 30)
- 32 Recording Speed [SP/EP] Button (☞ pg. 23)
- 33 PLAY Button (☞ pg. 22)
- 34 Fast-Forward [FF] Button (☞ pg. 22)
- 35 PAUSE Button (☞ pg. 24)
- 36 OK Button (☞ pg. 10)
- 37 SHUTTLE PLUS $\leftarrow \leftarrow \leftarrow \rightarrow \rightarrow \rightarrow$ ($\triangleleft \triangleright$) Button (☞ pg. 24, 25)
- 38 TV Volume [VOL.] +/- Button (☞ pg. 48)

The glow-in-the-dark buttons shown in white on the illustration above are helpful when using the remote control in darkened rooms.

Buttons with a small dot on the left side of the name can also be used to operate your TV while holding down the TV button. ☞ pg. 49

How To Use

The remote control can operate most of your VCR's functions, as well as basic functions of TV sets, Cable Boxes and DBS Receivers.

- Point the remote control toward the sensor window.
- The maximum operating distance of the remote control is about 8 m.

NOTES:

- When inserting the batteries, be sure to insert in the correct directions as indicated under the battery cover.
- If the remote control doesn't work properly, remove its batteries, wait a short time, replace the batteries and then try again.

GENERAL

Power requirement	: AC 120 V \sim , 60 Hz
Power consumption	
Power on	: 19 W
Power off	: 2.5 W
Temperature	
Operating	: 5°C to 40°C (41°F to 104°F)
Storage	: -20°C to 60°C (-4°F to 140°F)
Operating position	: Horizontal only
Dimensions (W x H x D)	: 400 x 94 x 281 mm (15-3/4" x 3-3/4" x 11-1/8")
Weight	: 3.2 kg (7.1 lbs)
Format	: VHS NTSC standard
Maximum recording time	
SP	: 210 min. with ST-210 video cassette
EP	: 630 min. with ST-210 video cassette

VIDEO/AUDIO

Signal system	: NTSC-type color signal and EIA monochrome signal, 525 lines/60 fields
Recording/ Playback system	: DA-4 (Double Azimuth) head helical scan system
Signal-to-noise ratio	: 45 dB
Horizontal resolution	: 240 lines
Frequency range	
Normal audio	: 70 Hz to 10,000 Hz
Hi-Fi audio	: 20 Hz to 20,000 Hz
Input/Output	: RCA connectors (IN x 2, OUT x 1)

TUNER

Tuning system	: Frequency-synthesized tuner
Channel coverage	
VHF	: Channels 2-13
UHF	: Channels 14-69
CATV	: 113 Channels
RF output	: Channel 3 or 4 (switchable; preset to Channel 3 when shipped) 75 ohms, unbalanced

TIMER

Clock reference	: Quartz
Program capacity	: 1-year programmable timer/ 8 programs
Memory backup time	: Approx. 10 min.

ACCESSORIES

Provided accessories	: RF cable (F-type), Infrared remote control unit, "AA" battery x 2, Controller
----------------------	--

Specifications shown are for SP mode unless otherwise specified. E. & O.E. Design and specifications subject to change without notice.

HOW TO LOCATE YOUR JVC SERVICE CENTER**TOLL FREE: 1-800-252-5722****<http://www.jvcservice.com>****Dear customer:**

In order to receive the most satisfaction from your purchase, read the instruction booklet before operating the unit. In the event that repair is necessary, or for the address nearest your location, please refer to the factory service center list below or within the Continental United States, call 1-800-252-5722 for your authorized servicer. Remember to retain your Bill of Sale for Warranty Service.

— JVC**JVC SERVICE & ENGINEERING
COMPANY OF AMERICA
DIVISION OF US JVC CORP.****FACTORY SERVICE CENTER LOCATIONS**

107 Little Falls Road
Fairfield, NJ 07004-2105
(973) 808-9279

5665 Corporate Avenue
Cypress, CA 90630-4727
(714) 229-8011

230 Eliot Street
Ashland, MA 01721-2377
(508) 881-5923

1500 Lakes Parkway
Lawrenceville, GA 30243-5857
(770) 339-2522

10700 Hammerly Boulevard, Suite 110
Houston, TX 77043-2310
(713) 935-9331

8192 W State Road 84
Davie, FL 33324-4611
(954) 472-1960

705 Enterprise Street
Aurora, IL 60504-8135
(630) 851-7855

2969 Mapunapuna Place, Suite 101
Honolulu, HI 96819-2000
(808) 833-5828

890 Dubuque Avenue
South San Francisco, CA 94080-1804
(650) 871-2666

Sophisticated electronic products may require occasional service. Just as quality is a keyword in the engineering and production of the wide array of JVC products, service is the key to maintaining the high level performance for which JVC is world famous. The JVC service and engineering organization stands behind our products.

NATIONAL HEADQUARTERS
JVC SERVICE & ENGINEERING COMPANY OF AMERICA
DIVISION OF US JVC CORP.
107 Little Falls Road
Fairfield, NJ 07004-2105

If you ship the product...

Pack your JVC unit in the original carton or one of equivalent size and strength. Enclose, with the unit, a letter stating the problem or symptom that exists and also a copy of the receipt or bill of sale you received when you purchased your JVC unit. Print your home return address on the outside and the inside of the carton. Send to the appropriate JVC Factory Service Center as listed above.

Don't service it yourself.**CAUTION**

*To prevent electrical shock, do not open the cabinet. No user serviceable parts inside.
Refer servicing to qualified service personnel.*

ACCESSORIES

*To purchase accessories for your JVC product, you may contact your local JVC Dealer.
Or from the 48 Continental United States call toll free:
1-800-882-2345.*

LIMITED WARRANTY**CONSUMER VIDEO 1-90**

JVC COMPANY OF AMERICA warrants this product and all parts thereof, except as set forth below ONLY TO THE ORIGINAL PURCHASER AT RETAIL to be FREE FROM DEFECTIVE MATERIALS AND WORKMANSHIP from the date of original retail purchase for the period as shown below. ("The Warranty Period")

PARTS	1 YR	LABOR	90 DAYS
-------	-------------	-------	----------------

THIS LIMITED WARRANTY IS VALID ONLY IN THE FIFTY (50) UNITED STATES, THE DISTRICT OF COLUMBIA AND IN COMMONWEALTH OF PUERTO RICO.

WHAT WE WILL DO:

If this product is found to be defective, JVC will repair or replace defective parts at no charge to the original owner. Such repair and replacement services shall be rendered by JVC during normal business hours at JVC authorized service centers. Parts used for replacement are warranted only for the remainder of the Warranty Period. All products and parts thereof may be brought to a JVC authorized service center on a carry-in basis except for Television sets having a screen size 25 inches and above which are covered on an in-home basis.

WHAT YOU MUST DO FOR WARRANTY SERVICE:

Return your product to a JVC authorized service center with a copy of your bill of sale. For your nearest JVC authorized service center, please call toll free: (800) 252-5722.

If service is not available locally, box the product carefully, preferably in the original carton, and ship, insured, with a copy of your bill of sale plus a letter of explanation of the problem to the nearest JVC Factory Service Center, the name and location of which will be given to you by the toll-free number.

If you have any questions concerning your JVC Product, please contact our Customer Relations Department.

WHAT IS NOT COVERED:

This limited warranty provided by JVC does not cover:

1. Products which have been subject to abuse, accident, alteration, modification, tampering, negligence, misuse, faulty installation, lack of reasonable care, or if repaired or serviced by anyone other than a service facility authorized by JVC to render such service, or if affixed to any attachment not provided with the products, or if the model or serial number has been altered, tampered with, defaced or removed;
2. Initial installation and installation and removal for repair;
3. Operational adjustments covered in the Owner's Manual, normal maintenance, video and audio head cleaning;
4. Damage that occurs in shipment, due to act of God, and cosmetic damage;
5. Signal reception problems and failures due to line power surge;
6. Video Pick-up Tubes/CCD Image Sensor, Cartridge, Stylus (Needle) are covered for 90 days from the date of purchase;
7. Accessories;
8. Batteries (except that Rechargeable Batteries are covered for 90 days from the date of purchase); from the date of purchase);

There are no other express warranties except as listed above.

THE DURATION OF ANY IMPLIED WARRANTIES INCLUDING THE IMPLIED WARRANTY OF MERCHANTABILITY, IS LIMITED TO THE DURATION OF THE EXPRESS WARRANTY HEREIN.

JVC SHALL NOT BE LIABLE FOR THE LOSS OF USE OF THE PRODUCT, INCONVENIENCE, LOSS OR ANY OTHER DAMAGES, WHETHER DIRECT, INCIDENTAL OR CONSEQUENTIAL (INCLUDING, WITHOUT LIMITATION, DAMAGE TO TAPES, RECORDS OR DISCS) RESULTING FROM THE USE OF THIS PRODUCT, OR ARISING OUT OF ANY BREACH OF THIS WARRANTY. ALL EXPRESS AND IMPLIED WARRANTIES, INCLUDING THE WARRANTIES OF MERCHANTABILITY AND FITNESS FOR PARTICULAR PURPOSE, ARE LIMITED TO THE WARRANTY PERIOD SET FORTH ABOVE.

Some states do not allow the exclusion of incidental or consequential damages or limitations on how long an implied warranty lasts, so these limitations or exclusions may not apply to you. This warranty gives you specific legal rights and you may also have other rights which vary from state to state.

JVC COMPANY OF AMERICA
DIVISION OF US JVC CORP.

1700 Valley Road
Wayne, New Jersey 07470

REFURBISHED PRODUCTS CARRY A SEPARATE WARRANTY, THIS WARRANTY DOES NOT APPLY. FOR DETAILS OF REFURBISHED PRODUCT WARRANTY, PLEASE REFER TO THE REFURBISHED PRODUCT WARRANTY INFORMATION PACKAGED WITH EACH REFURBISHED PRODUCT.

For customer use:

Enter below the Model No. and Serial No. which is located either on the rear, bottom or side of the cabinet. Retain this information for future reference.

Model No.: _____

Serial No.: _____

Purchase date: _____

Name of dealer: _____

JVC

VICTOR COMPANY OF JAPAN, LIMITED